

Semiconductor Product Catalog

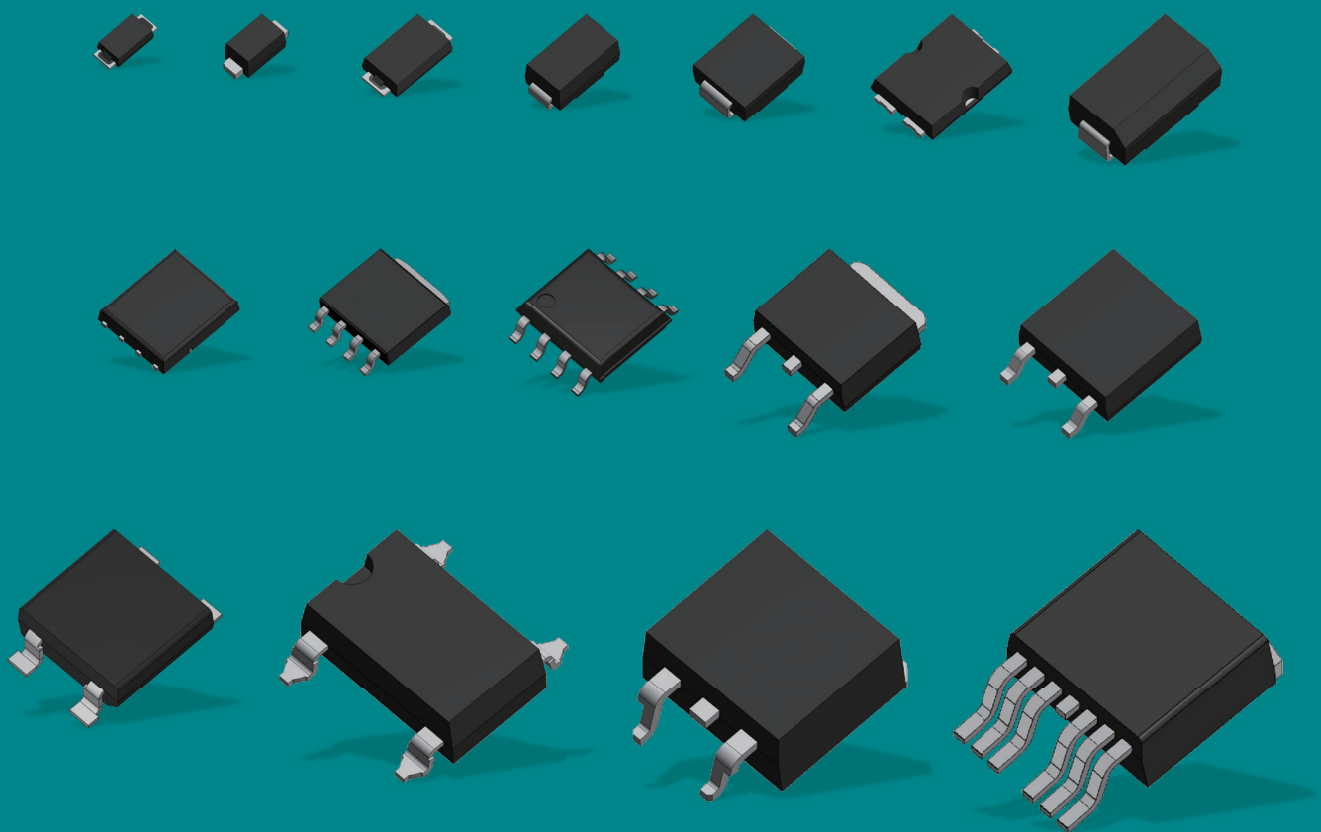

ShinDengen /

New power. Your power.

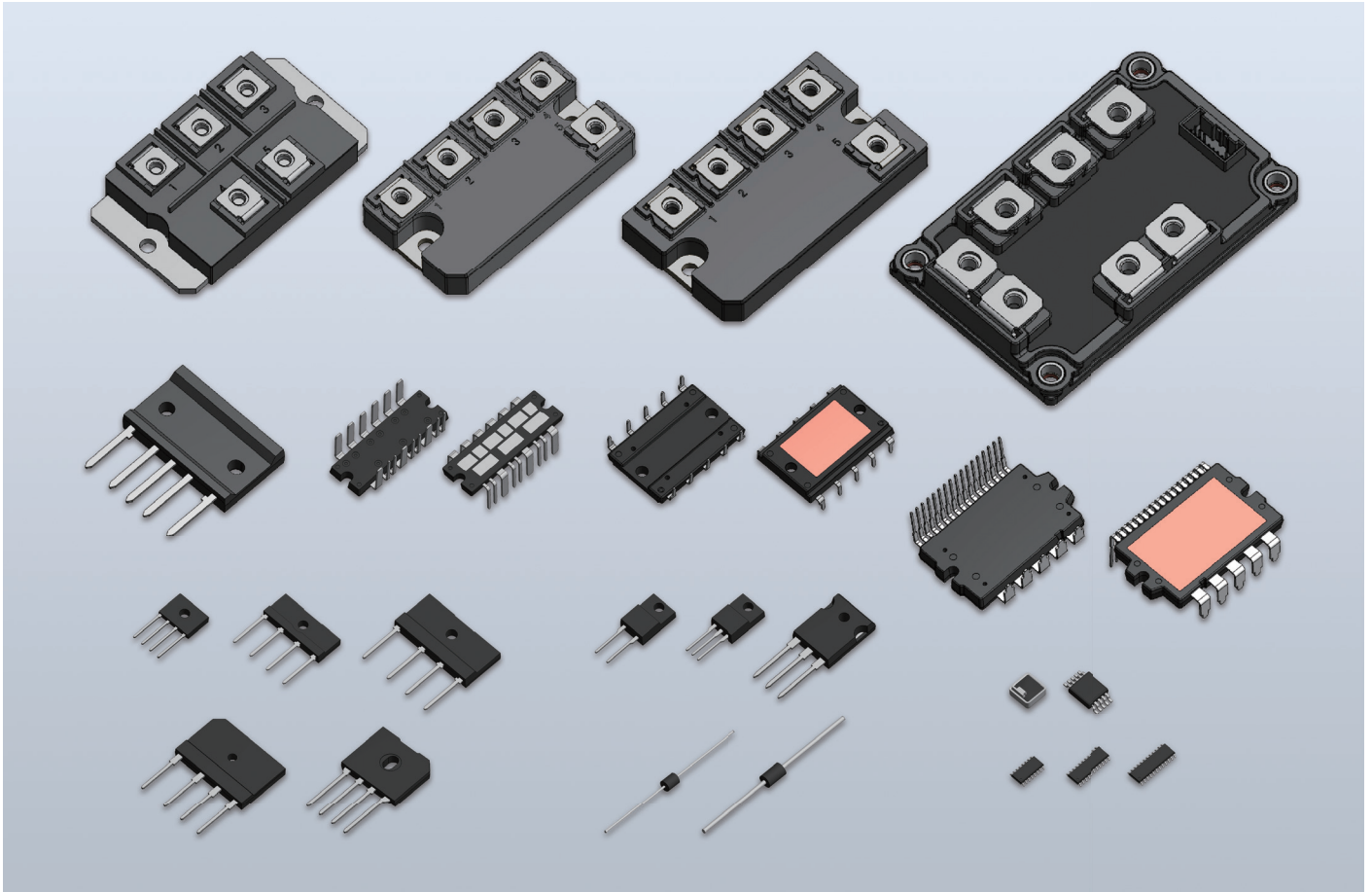

Notes

- ⚠ If you wish to use any such product, please be sure to refer to the specifications issued by Shindengen.
- ⚠ All products described or contained herein are designed with a quality level intended for use in standard applications requiring an ordinary level of reliability. If these products are to be used in equipment or devices for special or specific applications requiring an extremely high grade of quality or reliability in which failures or malfunctions of products may directly affect human life or health, a local Shindengen office must be contacted in advance to confirm that the intended use of the product is appropriate. Shindengen products are grouped into the following three applications according to the quality grade.
 - Standard applications
Computers, office automation and other office equipment, communication terminals, test and measurement equipment, audio/visual equipment, amusement equipment, consumer electronics, machine tools, personal electronic equipment, industrial equipment, etc.
 - Special applications
Transportation equipment (vehicles, ships, etc.), trunk-line communication equipment, traffic signal control systems, anti-disaster/crime systems, safety equipment, medical equipment, etc.
 - Specific applications
Nuclear reactor control systems, aircraft, aerospace equipment, submarine repeaters, life support equipment and systems, etc.
- ⚠ Although Shindengen continuously endeavors to enhance the quality and reliability of its products, customers are advised to consider and take safety measures in their design, such as redundancy, fire containment and anti-failure, so that personal injury, fires, or societal damages can be prevented.
- ⚠ Please note that all information described or contained herein is subject to change without notice due to product upgrades and other reasons. When buying Shindengen products, please contact the Company's offices or distributors to obtain the latest information.
- ⚠ Shindengen shall not bear any responsibility with regards to damages or infringement of any third-party patent rights and other intellectual property rights incurred due to the use of information on this website.
- ⚠ The information and materials on this website neither warrant the use of Shindengen's or any third party's patent rights and other intellectual property rights, nor grant license to such rights.
- ⚠ In the event that any product described or contained herein falls under the category of strategic products controlled under the Foreign Exchange and Foreign Trade Control Law of Japan, exporting of such products shall require an export license from the Japanese government in accordance with the above law.
- ⚠ No reprinting or reproduction of the materials on this website, either in whole or in part, is permitted without proper authorization from Shindengen.

P3-6	INDEX
P7-10	GENERAL RECTIFYING DIODES
P11-20	BRIDGE DIODES
P21-30	SCHOTTKY BARRIER DIODES
P31-36	FAST RECOVERY DIODES
P37-38	THYRISTORS
P39-40	SIDACs
P41-42	TRIACs
P43-44	SURGE ABSORBERS
P45-48	TVS (Transient Surge Suppressor)
P49-56	POWER MOSFETs
P57-58	POWER MODULES
P59-62	POWER ICs
P63-84	PACKAGE LIST • OUTLINE DIMENSIONS
P85-86	PACKING SPECIFICATION
P87	NOTES •How to Order •Outline of Packing Form •About AEC-Q101 & Automotive Grade

INDEX

Type No.	Page	Type No.	Page	Type No.	Page	Type No.	Page	Type No.	Page	Type No.	Page	Type No.	Page	Type No.	Page
D1F60	8	D3CE6S	22	D10FDC10ST	26	D30FDC4S	26	DF10SC6	26	G1VL10C	40	KL3Z18	44	MCZ5208SG	62
D1F60A	8	D3CE15ST	22	D10FR60LA	32	D30FDC10ST	26	DF10SC9	26	G1VL15C	40	KP20NU11	44	MCZ5209SN	62
D1FE60	8	D3CE20LUS	32	D10FR60V	8	D30FDC15ST	26	DF15JC10	26	G1VL20C	40	KP40NU11	44	MCZ5211ST	62
D1FH3	22	D3CE60K	32	D10FY4R5ST	22	D30JCB100K	18	DF15NC15	26	G1VL22C	40	KP40RU22	44	MCZ5216ST	62
D1FJ4	22	D3CE60V	8	D10FY4R5SY	22	D30JCT120V	16	DF15SC4M	26	G1VL24C	40	KU4F8	44	MCZ5601SC	62
D1FJ8	22	D3CE60VE	8	D10FY6ST	22	D30VC60	10	DF15VD60	10	K1V10	40	KU4F12	44	MCZ5606SC	62
D1FJ8A	22	D3F60	8	D10FY6SY	22	D30XBN20	18	DF16VC60R	10	K1V11	40	KU5S31NS	44	MCZ5607SC	62
D1FJ10	22	D3FE60	8	D10FY10ST	22	D30XT80	16	DF20JC10	26	K1V12	40	KU10L08	44	MF2003SV	62
D1FK60	32	D3FJ10	22	D10FY10SY	22	D35XB80	14	DF20L60	32	K1V14	40	KU10N14	44	MF2007SW	62
D1FK70	32	D3FK60	32	D10FY15ST	22	D40FDC10ST	26	DF20L60U	32	K1V22	40	KU10NU11	44	MG001AK028060A	58
D1FK100	32	D3FK120	32	D10FY60VE	8	D40FDC15ST	26	DF20LC20US	36	K1V22(W)	40	KU10NU13	44	MG001AL030060A	58
D1FK120	32	D3FS4A	22	D10JBB60V	14	D45JCT120V	16	DF20LC30	36	K1V24	40	KU10R23NS	44	MG031B090004A	58
D1FK120P	32	D3FS6	22	D10JBB80V	14	D45JCT160V	16	DF20NC15	26	K1V24(W)	40	KU10R27NS	44	MG031E120004A	58
D1FL20U	32	D3S4M	24	D10SBS4	18	D45XT80	16	DF20SC4M	26	K1V26	40	KU10R29NS	44	MG031G148004A	58
D1FL40U	32	D3S6M	24	D10XB60	14	D45XT160	16	DF20SC9M	26	K1V26(W)	40	KU10S31NS	44	MG031L080006A	58
D1FM3	22	D3SB60	14	D10XB60H	14	D50JCB80V	14	DF25SC6M	26	K1V36(W)	40	KU10S35NS	44	MG031MC148004A	58
D1FS4	22	D3SB80	14	D10XB80	14	D50XB80	14	DF25V60	8	K1V38(W)	40	KU15N14	44	MG031MD110006A	58
D1FS4A	22	D3SBA60	14	D15FR4ST	22	D70JHB80V	14	DF30JC4	26	K1V(A)10	40	LK25XB60	20	MG031N110006A	58
D1FS6	22	D4F60	8	D15FR60LA	32	D75JFT80V	16	DF30JC6	26	K1V(A)11	40	LL15XB60	20	MG032A4207R5A	58
D1FS6A	22	D4SB60L	14	D15FR60V	8	D100JHT80V	16	DF30JC10	26	K1V(A)12	40	LL25XB60	20	MG032B420010A	58
D1FT4	22	D4SB80	14	D15FY4R5ST	22	D100JHT120V	16	DF30NC15	26	K1V(A)16	40	LM25KBV60FR	20	MG038A200080A	18
D1FT4A	22	D4SBL20U	18	D15FY4R5SY	22	D100JHT160V	16	DF30SC3ML	26	K1VZL09	40	LM30KBV60FR	20	MG038B150080A	18
D1FT6	22	D4SBN20	18	D15FY6ST	22	D120SC4M	30	DF30SC4M	26	K1VZL20	40	LN1F60	8	MG038C200160A	18
D1FT6A	22	D4SBS4	18	D15FY6SY	22	D120SC6M	30	DF40SC3L	26	KC3FB40H	38	LN1WBA60	20	MG038D150160A	18
D1FT10	22	D4SBS6	18	D15FY10ST	22	D180SC4M	30	DF40SC4	26	KC5FB40H	38	LN4SB60	20	MG048A150004A	58
D1FT10A	22	D5CE4S	22	D15FY10SY	22	D180SC6M	30	DG1H3	22	KC5FB60H	38	LN6SB60	20	MG048B100006A	58
D1FT15A	22	D5FE60	8	D15FY15ST	22	D240SC4M	30	DG1H3A	22	KC5FB60HR	38	LN15XB60	20	MG055A	58
D1N60	8	D5FEC3SH	26	D15JAB60V	14	D240SC6M	30	DG1J10A	22	KC5FB60HRT	38	LN15XB60H	20	MG055B	58
D1N80	8	D5FY4R5ST	22	D15JAB80V	14	D360SC4M	30	DG1M3	22	KC5SF60HRT	38	LN25XB60	20	MG055F	58
D1NF60	34	D5FY4R5SY	22	D15XB60	14	D360SC6M	30	DG1M3A	22	KC8SF80	38	M1F60	8	MG055J	58
D1NK60	34	D5FY6ST	22	D15XB60H	14	DE3L20UA	32	DG1N15A	22	KD3FB60	42	M1F80	8	MG060B075080A	18
D1NK100	34	D5FY6SY	22	D15XB80	14	DE3S4M	22	DG1S4	22	KD3SF60	42	M1FE40	8	MG060C100080A	18
D1NL20U	34	D5FY10ST	22	D15XB100	14	DE3S6M	22	DG1S6	22	KD3SF60E	42	M1FE60	8	MG060E075160A	18
D1NL40U	34	D5FY10SY	22	D15XBN20	18	DE5L60A	32	DG1S6A	22	KD5SF60	42	M1FH3	22	MG061B150080A	18
D1NS4	24	D5FY15ST	22	D15XBS6	18	DE5L60U	32	DL04-18F1	46	KD5SF60S	42	M1FJ4	22	MG061C200080A	18
D1NS6	24	D5FY20SN	22	D20FD60LU	32	DE5LC20U	36	DL04-33F1	46	KD5SF80	42	M1FK60	32	MG061D100160A	18
D1UBA80	12	D5FY60K	32	D20FDC10ST	26	DE5S4M	22	DL04-36F1	46	KD8SF60	42	M1FL20U	32	MG061E150160A	18
D2CF60K	32	D5SB60	14	D20FDC15ST	26	DE5S6M	22	DL20B-27F2	46	KD8SF60S	42	M1FL40U	32	MG061F200160A	18
D2F60	8	D5SB80	14	D20FDC20L	36	DE5SC3ML	26	DL20B-30F2	46	KD8SF80	42	M1FM3	22	MH2501SC	62
D2FK60	32	D5SBA60	14	D20FDC20LUS	36	DE5SC4M	26	DL20B-33F2	46	KD12SF60	42	M1FS4	22	MH2511SC	62
D2FL20U	32	D6FEC4ST	26	D20FR4ST	22	DE5SC6M	26	DL20B-36F2	46	KD12SF60S	42	M1FS6	22	MS1003SH	62
D2FL40U	32	D6FEC10ST	26	D20FR4R5S	22	DE5VE40	8	G1V(A)8C	40	KD12SF80	42	M2F60	8	MS1004SH	62
D2FS4	22	D6FEC12ST	26	D20XB60	14	DE10S3L	22	G1V(A)10C	40	KD16SF60	42	M2FH3	22	MS1007SH	62
D2FS6	22	D6FEC15ST	26	D20XB80	14	DE10SC3L	26	G1V(A)12C	40	KD16SF60S	42	M2FL20U	32	MV1001SC	60
D2L20U	34	D6JBB60V	14	D20XBS6	18	DE10SC4	26	G1V(A)13C	40	KD16SF80	42	M2FM3	22	MV1002SC	60
D2L40U	34	D6JBB80V	14	D25FD60V	8	DF5VD60	10	G1V(A)14C	40	KD20SF60	42	M3F60	8	MV1011SC	60
D2S4M	24	D6SB60L	14	D25JAB60V	14	DF8L60US	32	G1V(A)15C	40	KD20SF60S	42	M3FE40	8	MV1012SC	60
D2S6M	24	D6SB80	14	D25JAB80V	14	DF10L60	32	G1V(A)20C	40	KD20SF80	42	M3FE60	8	MV2002SG	60
D2SB60	14	D6SBN20	18	D25XB60	14	DF10LC20U	36	G1V(B)20C	40	KL3L07	44	M3FL20U	32	MV2052SG	60
D2SB60A	14	D8FD60LUS	32	D25XB80	14	DF10LC30	36	G1V(B)22C	40	KL3N14	44	MCZ5203SE	62	POR5B60HP2	56
D2SBA60	14	D8JBB60V	14	D25XB100	14	DF10NC15	26	G1V(B)24C	40	KL3R20	44	MCZ5205SE	62	P1B52HP2	56
D3CE4S	22	D8JBB80V	14	D30FD60K	32	DF10SC4M	26	G1VL8C	40	KL3Z07	44	MCZ5207SG	62	P1B90VX3	56

INDEX











Type No.	Page	Type No.	Page	Type No.	Page	Type No.	Page	Type No.	Page	Type No.	Page	Type No.	Page	Type No.	Page
P1FE90VX3	56	P18LF6QNK	50	P39LF6QTKD	54	P90FG5R5SL	52	S10VTA80	18	SF3K60M	34	SG30TC15M	28	ST04-39F1	46
P1R5B40HP2	56	P19LA10SL	50	P40B6SL	52	P94FG5R5SL	52	S10WB60	16	SF3L60U	34	SG40TC10M	28	ST06-18CE	46
P2B60HP2F	56	P20B12SL	52	P40B10SL	52	P98LF6QL	50	S15VB60	16	SF5K60M	34	SG40TC12M	28	ST06-27CE	46
P2B90VX3	56	P20B12SN	52	P40B10SN	52	P98LF6QLK	50	S15VT60	18	SF5L40UM	34	ST02-12G1	46	ST06-30CE	46
P2R5B52HP2F	56	P20F50HP2	56	P40F10SN	52	P98LF6QN	50	S15VT80	18	SF5L60U	34	ST02-14G1	46	ST06-33CE	46
P3B28HP2	56	P20FE12SLK	52	P40F12SN	52	P98LF6QNK	50	S15VTA60	18	SF5LC40UM	36	ST02-16G1	46	ST06-36CE	46
P3F60HP2	56	P20LF4QTKD	54	P40LF12SL	50	P105LF4QL	50	S15VTA80	18	SF8K60M	34	ST02-18G1	46	ST06-39CE	46
P4B40HP2	56	P21F28HP2	56	P40LF12SLK	50	P105LF4QLK	50	S15WB60	16	SF8K60USM	34	ST02-20G1	46	ST20-27F2	46
P4B60HP2F	56	P21F60EVA	56	P40LF12SN	50	P105LF4QN	50	S20K60T	34	SF10K60M	34	ST02-24G1	46	ST20-30F2	46
P4F60HP2	56	P22F10SN	52	P40LF12SNK	50	P105LF4QNK	50	S20K100V	34	SF10KC60M	36	ST02-27G1	46	ST20-33F2	46
P4F90VX3	56	P22FE4SBK	52	P41LF4QTKD	54	P140LF4QL	50	S20LC20UST	36	SF10L60AM	34	ST02-30G1	46	ST20-36F2	46
P5B50HP2F	56	P23F40HP2FM	56	P42F6EN	52	P140LF4QLK	50	S20LC30T	36	SF10L60MSM	34	ST02-33G1	46	ST20-47F2	46
P5B52HP2	56	P23LA10SL	50	P46LF7R5SL	50	P140LF4QN	50	S20LC40UT	36	SF10L60MVM	34	ST02-36G1	46	ST60-40MF	46
P5F50HP2	56	P24B4SB	52	P46LF7R5SLK	50	P140LF4QNK	50	S20LC40UV	36	SF10L60U	34	ST02-39G1	46	ST60-48MF	46
P5F60HP2	56	P24LF4QLK	50	P46LF7R5SN	50	P170FZ6QNKA	52	S20LC60UST	36	SF10LC40UM	36	ST02-43G1	46	ST70-27F	46
P6B28HP2	56	P24LF4QMK	50	P46LF7R5SNK	50	P240FZ4QLA	52	S20LC60USV	36	SF20K60M	34	ST02-47G1	46	ST70-27FZ	46
P6B40HP2	56	P24LF4QNK	50	P50F10SN	52	P240FZ4QNKA	52	S20SC9MT	28	SF20KC60M	36	ST02-58G1	46	ST70-27MF	46
P6B52HP2	56	P25B6EB	52	P50LF4QTKD	54	S1NAD80	10	S20SC65WV	28	SF20L60AM	34	ST02-75F1	46	ST70-30MF	46
P6F50HP2	56	P25F60EVA	56	P50LF10SL	50	S1NB60	12	S20VT60	18	SF20L60MSM	34	ST02-82F1	46	ST80-14MF	46
P7F60HP2	56	P25LA12SL	50	P50LF10SLK	50	S1NB80	12	S20VT80	18	SF20L60MVM	34	ST02-100F1	46	UD2KB80	14
P7F90VX3	56	P25LF12SL	50	P50LF10SN	50	S1NBB80	12	S20VTA60	18	SF20L60U	34	ST02-120F1	46	UD3KB80	14
P8B10SB	52	P25LF12SLK	50	P50LF10SNK	50	S1NBC60	12	S20VTA80	18	SF20LC30M	36	ST02-140F1	46	UD4KB80	14
P8B10SBK	52	P25LF12SN	50	P54B4SN	52	S1NBC80	12	S20WB60	16	SG5L20USM	34	ST02-170F1	46	UD6KBA80	14
P8B28HP2	56	P25LF12SNK	50	P55F6EN	52	S1WB(A)60	12	S20WB80	16	SG5LC20USM	36	ST02-200F1	46	UD8KBA80	14
P8B30HP2	56	P26B10SL	52	P56LA4SN	50	S1WB(A)60B	12	S25VB60	16	SG5S4M	24	ST02-280F1	46	US8KB80R	14
P8F28HP2	56	P26B10SLK	52	P60B4EL	52	S1WB(A)80	12	S25VB80	16	SG5S6M	24	ST02-320F1	46	US10KB80R	14
P8F50HP2	56	P26B10SN	52	P60B4SN	52	S1ZAS4	30	S30K60T	34	SG5S9M	24	ST02D-82	48	US15KB80R	14
P8FE10SBK	52	P26F28HP2	56	P60B6EL	52	S1ZB60	12	S30K60V	34	SG8SC4M	28	ST02D-140	48	US20KB80R	14
P9B30HP2F	56	P26FE10SLK	52	P60B6EN	52	S1ZB80	12	S30K100V	34	SG10L20USM	34	ST02D-140F2	48	US30KB80R	14
P9B40HP2	56	P30B10EL	52	P60B6SN	52	S2K100	34	S30SC4MT	28	SG10LC20USM	36	ST02D-170	48	US30KBV80FR	14
P10B28HP2	56	P30FE4SLK	52	P64LF6QL	50	S2L20U	34	S30SC6MT	28	SG10SC3LM	28	ST02D-170F2	48	VR61F1	44
P10F50HP2	56	P30FE6SLK	52	P64LF6QLK	50	S2L40U	34	S30TC15T	28	SG10SC4M	28	ST02D-200	48		
P10F60HP2	56	P30FE7R5SLK	52	P64LF6QN	50	S2L60	34	S30V60T	10	SG10SC6M	28	ST03-43F1	46		
P11F60EVA	56	P30LA10SL	50	P64LF6QNK	50	S2NBC100	12	S30V80V	10	SG10SC9M	28	ST03-47F1	46		
P12F60HP2	56	P30W60HP2V	56	P66F7R5SN	52	S2V60	8	S30VT60	18	SG10TC15M	28	ST03-58F1	46		
P12FE7R5SBK	52	P32B12SLK	52	P66F7R5SNK	52	S2V80	8	S30VT80	18	SG15SC4M	28	ST03-68F1	46		
P12LF10SLK	54	P32B12SN	52	P70F5EN	52	S2VB60	16	S30VT160	18	SG15SC6M	28	ST03-240F1	46		
P13F28HP2	56	P32F12SN	52	P70F7R5EN	52	S2WB(A)80	12	S30VTA60	18	SG20JC6M	28	ST03D-82	48		
P13F50HP2	56	P32FG15SL	52	P70LF4QL	50	S3K60	34	S30VTA80	18	SG20LC20USM	36	ST03D-140	48		
P14FE6SBK	52	P32LF10SL	50	P70LF4QLK	50	S3L20U	34	S30VTA160	18	SG20SC3LM	28	ST03D-170	48		
P15F50HP2	56	P32LF10SLK	50	P70LF4QN	50	S3L40U	34	S40HC1R5T	28	SG20SC4M	28	ST03D-200	48		
P15F60HP2	56	P32LF10SN	50	P70LF4QNK	50	S3L60	34	S40T15V	24	SG20SC6M	28	ST03DH-240	48		
P15F60HP2F	56	P32LF10SNK	50	P72LF7R5SL	50	S3V60	8	S50VB60	16	SG20SC9M	28	ST04-12F1	46		
P15LA12SL	50	P33LF6QLKD	54	P72LF7R5SLK	50	S3V80	8	S50VB80	16	SG20TC10M	28	ST04-14F1	46		
P15LF6QTKD	54	P33LF6QTKD	54	P72LF7R5SN	50	S3V100D	8	S60HC1R5T	28	SG20TC12M	28	ST04-16F1	46		
P16B6SB	52	P34F6EL	52	P72LF7R5SNK	50	S3WB60	16	S60HC3T	28	SG20TC15M	28	ST04-18F1	46		
P16B6SBK	52	P36F25HP2	56	P80FG6EAL	52	S4VB60	16	S60JC10V	28	SG30JC6M	28	ST04-20F1	46		
P16F60EVA	56	P36F28HP2	56	P80FG7R5EN	52	S5VB60	16	S60L120V	34	SG30SC3LM	28	ST04-24F1	46		
P17F28HP2	56	P38LF6QL	50	P82F7R5SN	52	S10VB60	16	S60SC3LT	28	SG30SC4M	28	ST04-27F1	46		
P17LF10SLK	54	P38LF6QLK	50	P85FG6EAL	52	S10VT60	18	S60SC4MT	28	SG30SC6M	28	ST04-30F1	46		
P18LA12SL	50	P38LF6QN	50	P85GC28HP2F	56	S10VT80	18	S60SC6MT	28	SG30TC10M	28	ST04-33F1	46		
P18LF6QLK	50	P38LF6QNK	50	P86F6SN	52	S10VTA60	18	S90T15V	24	SG30TC12M	28	ST04-36F1	46		



GENERAL RECTIFYING DIODES

General Rectifying Diodes are defined as high-voltage and PN junction type devices.

These devices utilize our original glass passivation which is physically stable with a superior structure for resistance against heat and humidity. Variations are available for breakdown voltage up to 800V and output current from 1 to 30A.

Single

Surface Mount							
Package	JEDEC Code JEITA Code House Name	Fig.	IF (AV) [A]	VRRM [V]			Remarks
				400	600	800	
 3.9 × 1.8 × 1.4(mm)	DO-219AA similar M1F	B2	1		M1F60 M1FE60	M1F80	① — >— ②
			2	M1FE40			
 5.0 × 2.5 × 2.0(mm)	DO-214AC 1F	B3-1	1		D1F60 D1FE60		
			1.1		LN1F60		
			1.2		D1F60A		
 4.7 × 2.4 × 0.98(mm)	SC-110B CE	B5-1	3		D3CE60V		
			3.5		D3CE60VE		
 5.1 × 3.75 × 2.0(mm)	DO-214AA similar M2F	B6	1.2		M2F60		
			3	M3FE40	M3F60 M3FE60		
 7.6 × 4.0 × 2.8(mm)	— 2F	B9-1	1.4		D2F60		
			3		D3F60 D3FE60		
			4		D4F60		
			5		D5FE60		
 9.5 × 6.6 × 2.65(mm)	SC-63 E-pack	G1-5	5	DE5VE40			①④ — >— ② N.C. ③
 6.5 × 4.5 × 1.1(mm)	TO-277A similar FY	G4	10		D10FY60VE		① — >— ②③
 9.6 × 6.6 × 2.3(mm)	TO-252AA similar FR	G5	10		D10FR60V		① — >— ②④ ③ N.C.
			15		D15FR60V		
 13.2 × 10.2 × 4.7(mm)	SC-83 similar STO-220	H1-2	25		DF25V60		①②④ — >— ③
 13.2 × 10.2 × 4.6(mm)	SC-83 similar FD	H2-1	25		D25FD60V		① — >— ②④ ③ N.C.

Axial							
Package	JEDEC Code JEITA Code House Name	Fig.	IF (AV) [A]	VRRM [V]			Remarks
				400	600	800	
 3.0 × φ 2.6(mm)	— AX057	A1	1		D1N60	D1N80	① — >— ②
 7.0 × φ 4.4(mm)	— AX10	A5-1	1.7		S2V60	S2V80	
 7.0 × φ 4.4(mm)	— AX14	A7	3			S3V100D	
			3.5		S3V60	S3V80	

Single

Surface Mount														
Package		Type No.	Absolute Maximum Ratings					Electrical Characteristics				Halogen free	Based on AEC-Q101	Automotive
JEDEC Code JEITA Code House Name	Fig.		VRRM [V]	IF (AV) [A]	Conditions Ta [°C]	IFSM [A]	Tj [°C]	Vf (max) [V]	Conditions IF [A]	Ir (max) Vr=VRRM [μA]	VESD (typ) [kV]			
DO-219AA similar M1F	B2	M1F60	600	1	25	25	150	1.10	1	10	—	—	—	○
		M1FE60	600	1	129 *1	30	150	1.10	1	10	25	—	○	○
		M1F80	800	1	25	25	150	1.10	1	10	—	—	—	○
		M1FE40	400	2	103 *2	25	150	1.10	1	10	—	—	—	○
DO-214AC 1F	B3-1	D1F60	600	1	25	25	150	1.10	1	10	—	—	—	○
		D1FE60	600	1	126 *1	30	150	1.10	1	10	25	—	○	○
		LN1F60 *3	600	1.1	25	25	150	1.05	0.8	10	—	—	—	○
		D1F60A	600	1.2	25	45	150	0.97	1.2	10	—	—	—	○
SC-110B CE	B5-1	D3CE60V	600	3	101 *1	50	150	1.10	3	10	—	—	—	○
		D3CE60VE	600	3.5	93 *1	60	-55 to 150	1.10	3.5	10	25	—	○	■
DO-214AA similar M2F	B6	M2F60	600	1.2	51	50	150	0.97	1.2	10	—	—	—	○
		M3FE40	400	3	76 *1	75	150	1.10	3	10	30	—	○	○
		M3F60	600	3	100 *1	90	150	1.05	3	10	—	—	—	○
		M3FE60	600	3	76 *1	90	150	1.05	3	10	25	—	○	○
— 2F	B9-1	D2F60	600	1.4	25	60	150	1.05	1.4	10	—	—	—	○
		D3F60	600	3	80 *1	150	150	1.05	3	10	—	—	—	○
		D3FE60	600	3	105 *1	150	150	1.05	3	10	25	—	○	○
		D4F60	600	4	68 *1	200	150	0.95	4	10	—	—	—	○
		D5FE60	600	5	82 *1	300	150	0.95	5	10	25	—	○	○
SC-63 E-pack	G1-5	DE5VE40	400	5	130 *2	80	150	1.00	5	10	30	—	—	■
TO-277A similar FY	G4	D10FY60VE	600	10	120 *1	220	-55 to 150	1.10	10	10	25	○	○	○
TO-252AA similar FR	G5	D10FR60V	600	10	130 *2	200	-55 to 150	1.05	10	10	—	—	—	■
		D15FR60V	600	15	125 *2	300	-55 to 150	1.05	15	10	—	—	—	■
SC-83 similar STO-220	H1-2	DF25V60	600	25	136 *2	400	150	1.10	25	10	—	—	—	—
SC-83 similar FD	H2-1	D25FD60V	600	25	113 *2	450	150	1.10	25	10	—	—	○	○

*1 : Tl *2 : Tc *3 : trr(max)=3.5μs ■ : Please contact us.

Axial														
Package		Type No.	Absolute Maximum Ratings					Electrical Characteristics				Halogen free	Based on AEC-Q101	Automotive
JEDEC Code JEITA Code House Name	Fig.		VRRM [V]	IF (AV) [A]	Conditions Ta [°C]	IFSM [A]	Tj [°C]	Vf (max) [V]	Conditions IF [A]	Ir (max) Vr=VRRM [μA]	VESD (typ) [kV]			
— AX057	A1	D1N60	600	1	25	30	150	1.05	1	10	—	—	—	—
		D1N80	800	1	25	30	150	1.05	1	10	—	—	—	—
— AX10	A5-1	S2V60	600	1.7	40	60	150	1.05	1.7	10	—	—	—	—
		S2V80	800	1.7	40	60	150	1.05	1.7	10	—	—	—	—
— AX14	A7	S3V100D	800	3	130 *1	150	150	1.05	3	10 *2	—	—	—	—
		S3V60	600	3.5	40	120	150	1.05	2.6	10	—	—	—	—
		S3V80	800	3.5	40	120	150	1.05	2.6	10	—	—	—	—

*1 : Tl *2 : Vr=1000V

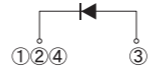

GENERAL RECTIFYING DIODES

Single

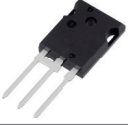
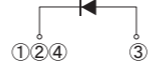
Two Terminal Type							
Package	JEDEC Code JEITA Code House Name	Fig.	I _{F(AV)} [A]	V _{RRM} [V]			Remarks
				400	600	800	
 41.0 × 16.0 × 5.0(mm)	TO-247AD — MTO-3PT	K2	30		S30V60T		

Three Terminal Type							
Package	JEDEC Code JEITA Code House Name	Fig.	I _{F(AV)} [A]	V _{RRM} [V]			Remarks
				400	600	800	
 41.0 × 16.0 × 5.0(mm)	TO-247AD — MTO-3PV	K6	30		S30V80V		

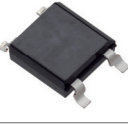
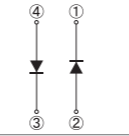
Array

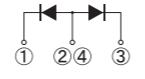
Surface Mount							
Package	JEDEC Code JEITA Code House Name	Fig.	I _{F(AV)} [A]	V _{RRM} [V]			Remarks
				400	600	800	
 10.0 × 6.8 × 2.6(mm)	— — 1NA	C6-2	3		S1NAD80		
 13.2 × 10.2 × 4.7(mm)	— SC-83 similar STO-220	H1-5	5		DF5VD60		
			15		DF15VD60		
		H1-7	16		DF16VC60R		

Diode Module

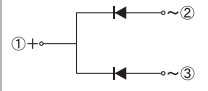
Diode Module							
Package	JEDEC Code JEITA Code House Name	Fig.	I _{F(AV)} [A]	V _{RRM} [V]			Remarks
				400	600	800	
 22.3 × 22.3 × 25.0(mm)	— — D30VC	E2	30		D30VC60		

Single

Two Terminal Type														
Package		Type No.	Absolute Maximum Ratings					Electrical Characteristics				Halogen free	Based on AEC-Q101	Automotive
JEDEC Code JEITA Code House Name	Fig.		V _{RRM} [V]	I _{F(AV)} [A]	Conditions T _C [°C]	I _{FSM} [A]	T _J [°C]	V _F (max) [V]	Conditions I _F [A]	I _R (max) V _R =V _{RRM} [μA]	V _{ESD} (typ) [kV]			
TO-247AD — MTO-3PT	K2	S30V60T	600	30	119	360	150	1.1	30	10	—	—	—	—

Three Terminal Type														
Package		Type No.	Absolute Maximum Ratings					Electrical Characteristics				Halogen free	Based on AEC-Q101	Automotive
JEDEC Code JEITA Code House Name	Fig.		V _{RRM} [V]	I _{F(AV)} [A]	Conditions T _C [°C]	I _{FSM} [A]	T _J [°C]	V _F (max) [V]	Conditions I _F [A]	I _R (max) V _R =V _{RRM} [μA]	V _{ESD} (typ) [kV]			
TO-247AD — MTO-3PV	K6	S30V80V	800	30	131	450	150	1.1	30	10	—	—	—	○

Array

Surface Mount														
Package		Type No.	Absolute Maximum Ratings					Electrical Characteristics				Halogen free	Based on AEC-Q101	Automotive
JEDEC Code JEITA Code House Name	Fig.		V _{RRM} [V]	I _{F(AV)} [A]	Conditions T _C [°C]	I _{FSM} [A]	T _J [°C]	V _F (max) [V]	Conditions I _F [A]	I _R (max) V _R =V _{RRM} [μA]	V _{ESD} (typ) [kV]			
— — 1NA	C6-2	S1NAD80	800	3	102 *	110	150	1.05	0.75	10	—	—	—	—
— SC-83 similar STO-220	H1-5	DF5VD60	600	5	140	140	150	1.05	2.50	10	—	—	—	—
		DF15VD60	600	15	127	190	150	1.05	7.50	10	—	—	—	—
	H1-7	DF16VC60R	600	16	124	190	150	1.05	8.00	10	—	—	—	—

* : T_J

Diode Module







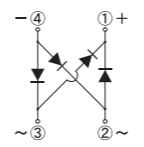

Diode Module														
Package		Type No.	Absolute Maximum Ratings					Electrical Characteristics				Halogen free	Based on AEC-Q101	Automotive
JEDEC Code JEITA Code House Name	Fig.		V _{RRM} [V]	I _{F(AV)} [A]	Conditions T _C [°C]	I _{FSM} [A]	T _J [°C]	V _F (max) [V]	Conditions I _F [A]	I _R (max) V _R =V _{RRM} [μA]	V _{ESD} (typ) [kV]			
— — D30VC	E2	D30VC60	600	30	124	300	150	1.05	15	10	—	—	—	—

BRIDGE DIODES

Bridge Diodes are suitable for the rectification of commercial frequency.







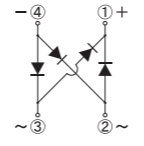

Variations are available for various packaging as well as high voltage (Max 1600V), high IFSM, low VF, and low noise.

Small Bridge Diodes

Surface Mount							
Package	JEDEC Code JEITA Code House Name	Fig.	IF(AV) [A]	VRRM [V]			Remarks
				600	800	1000	
 7.0 × 4.7 × 2.6(mm)	TO-269AA 1Z	C2-1	0.8	S1ZB60	S1ZB80		
 6.2 × 5.15 × 1.45(mm)	SOPA-4	C1	1		D1UBA80		
 10.0 × 6.8 × 2.6(mm)	1N	C4	1	S1NB60	S1NB80		
 10.0 × 6.8 × 2.6(mm)	1NA	C6-1	1		S1NBB80		
 10.0 × 6.8 × 2.6(mm)	1NA	C6-1	1.5	S1NBC60	S1NBC80		
 10.0 × 6.8 × 2.6(mm)	1NA	C6-1	2			 S2NBC100	
 10.6 × 10.2 × 3.1(mm)	1W	C8	1	S1WB(A)60 S1WB(A)60B	S1WB(A)80		
 10.6 × 10.2 × 3.1(mm)	1W	C8	2		S2WB(A)80		

 : New product

THD (Through Hole Device)

THD (Through Hole Device)							
Package	JEDEC Code JEITA Code House Name	Fig.	IF(AV) [A]	VRRM [V]			Remarks
				600	800	1000	
 3.8 × 4.7 × 2.5(mm)	1Z	C3	0.8	S1ZB60	S1ZB80		
 6.5 × 6.8 × 2.5(mm)	1N	C5	1	S1NB60	S1NB80		
 6.5 × 6.8 × 2.5(mm)	1NA	C7	1		S1NBB80		
 6.5 × 6.8 × 2.5(mm)	1NA	C7	1.5	S1NBC60	S1NBC80		
 6.5 × 6.8 × 2.5(mm)	1NA	C7	2			 S2NBC100	
 6.2 × 10.2 × 3.0(mm)	1W	C9	1	S1WB(A)60 S1WB(A)60B	S1WB(A)80		
 6.2 × 10.2 × 3.0(mm)	1W	C9	2		S2WB(A)80		

 : New product

Small Bridge Diodes

Surface Mount															
JEDEC Code JEITA Code House Name	Package	Fig.	Type No.	Spec. Code	Absolute Maximum Ratings				Electrical Characteristics			Halogen free	UL	Automotive	
					VRRM [V]	IF(AV) [A]	Conditions Ta [°C]	IFSM [A]	Tj [°C]	Vf(max) [V]	Conditions IF [A]				IR(max) Vr=VRRM [μA]
TO-269AA	C2-1		S1ZB60	-7072	600	0.8	25	30	150	1.05	0.4	10	-	-	-
1Z			S1ZB80	-7072	800	0.8	25	30	150	1.05	0.4	10	-	-	-
SOPA-4	C1		D1UBA80	-7062	800	1	25	30	150	0.95	0.4	10	-	-	-
1N	C4		S1NB60	-7062	600	1	25	30	150	1.05	0.5	10	-	-	-
1N			S1NB80	-7062	800	1	25	30	150	1.05	0.5	10	-	-	-
1NA	C6-1		S1NBB80	-7062	800	1	26	50	150	1.05	0.5	10	-	-	-
1NA			S1NBC60	-7062	600	1.5	105 *1	60	150	1.05	0.75	10	-	-	-
1NA			S1NBC80	-7062	800	1.5	105 *1	60	150	1.05	0.75	10	-	-	-
1NA	C6-1		 S2NBC100	-7062	1000	2	93 *1	65 *2	150	1.05	1	10	-	-	-
1W	C8		S1WB(A)60	-7062	600	1	25	30	150	1.00	0.5	10	-	-	-
1W			S1WB(A)60B	-7062	600	1	25	50	150	1.00	0.5	10	-	-	-
1W			S1WB(A)80	-7062	800	1	25	30	150	1.00	0.5	10	-	-	-
1W			S2WB(A)80	-7062	800	2	112 *1	50	-40 to 150	1.05	1	10	-	-	-

 : New product *1 : Tl *2 : 60Hz









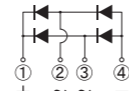

THD (Through Hole Device)

THD (Through Hole Device)															
JEDEC Code JEITA Code House Name	Package	Fig.	Type No.	Spec. Code	Absolute Maximum Ratings				Electrical Characteristics			Halogen free	UL	Automotive	
					VRRM [V]	IF(AV) [A]	Conditions Ta [°C]	IFSM [A]	Tj [°C]	Vf(max) [V]	Conditions IF [A]				IR(max) Vr=VRRM [μA]
1Z	C3		S1ZB60	-7101	600	0.8	25	30	150	1.05	0.4	10	-	-	-
1Z			S1ZB80	-7101	800	0.8	25	30	150	1.05	0.4	10	-	-	-
1N	C5		S1NB60	-7101	600	1	25	30	150	1.05	0.5	10	-	-	-
1N			S1NB80	-7101	800	1	25	30	150	1.05	0.5	10	-	-	-
1NA	C7		S1NBB80	-7101	800	1	26	50	150	1.05	0.5	10	-	-	-
1NA			S1NBC60	-7101	600	1.5	105 *1	60	150	1.05	0.75	10	-	-	-
1NA			S1NBC80	-7101	800	1.5	105 *1	60	150	1.05	0.75	10	-	-	-
1NA	C7		 S2NBC100	-7101	1000	2	93 *1	65 *2	150	1.05	1	10	-	-	-
1W	C9		S1WB(A)60	-7101	600	1	25	30	150	1.00	0.5	10	-	-	-
1W			S1WB(A)60B	-7101	600	1	25	50	150	1.00	0.5	10	-	-	-
1W			S1WB(A)80	-7101	800	1	25	30	150	1.00	0.5	10	-	-	-
1W			S2WB(A)80	-7101	800	2	112 *1	50	-40 to 150	1.05	1	10	-	-	-

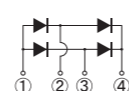
 : New product *1 : Tl *2 : 60Hz

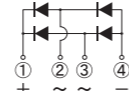
BRIDGE DIODES

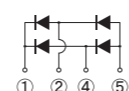
SIP (Single In-line Package) Bridge Diodes

THD (Through Hole Device)								
Package	JEDEC Code JEITA Code House Name	Fig.	IF (AV) [A]	VRRM [V]			Remarks	
				600	800	1000		
 24.0 × 13.8 × 3.1(mm)	-	D3K	D1	2		UD2KB80		
				3		UD3KB80		
				4		UD4KB80		
				6		UD6KBA80		
				8		UD8KBA80		
 24.5 × 20.0 × 3.5(mm)	-	2S	D2	1.5	D2SBA60 D2SB60			
				2	D2SB60A			
 25.2 × 25.0 × 4.2(mm)	-	JB	D5	6	D6JBB60V	D6JBB80V		
				8	D8JBB60V	D8JBB80V		
				10	D10JBB60V	D10JBB80V		
 32.5 × 25.0 × 4.6(mm)	-	3S	D3	4	D3SBA60 D3SB60 D4SB60L	D3SB80 D4SB80		
				10	D10XB60 D10XB60H	D10XB80		
 37.1 × 22.1 × 3.45(mm)	-	D6K	D11	8		US8KB80R		
				10		US10KB80R		
				15		US15KB80R		
				20		US20KB80R		
				30		US30KB80R US30KBV80FR		
 29.4 × 29.0 × 4.6(mm)	-	JA	D6	15	D15JAB60V	D15JAB80V		
				25	D25JAB60V	D25JAB80V		
 37.5 × 30.0 × 4.6(mm)	-	5S	D4	6	D5SBA60 D5SB60 D6SB60L	D5SB80 D6SB80		
				15	D15XB60 D15XB60H	D15XB80		D15XB100
				20	D20XB60	D20XB80		
				25	D25XB60	D25XB80		D25XB100
				35		D35XB80		
 47.0 × 45.7 × 7.5(mm)	-	TSB(4pin)	D7	50		D50XB80		
				50		D50JCB80V		
 47.0 × 45.7 × 7.5(mm)	-	JC(4pin)	D7	50		D50JCB80V		
				50		D50JCB80V		

DIP (Dual In-line Package) Bridge Diode

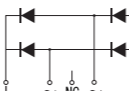
Package	JEDEC Code JEITA Code House Name	Fig.	IF (AV) [A]	VRRM [V]			Remarks
				600	800	1000	
 45.7 × 30.0 × 8.6(mm)	- -	D10-1	70		D70JHB80V		

SIP (Single In-line Package) Bridge Diodes

THD (Through Hole Device)													
JEDEC Code JEITA Code House Name	Fig.	Type No.	Absolute Maximum Ratings					Electrical Characteristics			Halogen free	UL	Automotive
			VRRM [V]	IF (AV) [A]	Conditions Tc [°C]	IFSM [A]	Tj [°C]	Vf (max) [V]	Conditions IF [A]	IR (max) VR=VRRM [μA]			
-	D3K	UD2KB80	800	2 *3	143	62 *3	150	1.05	1	10	-	UL	-
		UD3KB80	800	3 *3	140	90 *3	150	1.05	1.5	10	-	UL	-
		UD4KB80	800	4 *3	138	135 *3	150	1.00	2	10	-	UL	-
		UD6KBA80	800	6 *3	131	135 *3	150	1.05	3	10	-	UL	-
		UD8KBA80	800	8 *3	126	165 *3	150	1.05	4	10	-	UL	-
-	2S	D2SBA60	600	1.5	25 *1	60	150	1.05	0.75	10	-	-	-
		D2SB60	600	1.5	25 *1	80	150	1.05	0.75	10	-	-	-
		D2SB60A	600	2	115 *2	120	150	0.95	1	10	-	-	-
-	JB	D6JBB60V	600	6	131	100	150	1.05	3	10	-	UL	-
		D6JBB80V	800	6	131	100	150	1.05	3	10	-	UL	-
		D8JBB60V	600	8	130	130	150	1.05	4	10	-	UL	-
		D8JBB80V	800	8	130	130	150	1.05	4	10	-	UL	-
		D10JBB60V	600	10	129	150	150	1.05	5	10	-	UL	-
-	3S	D10JBB80V	800	10	129	150	150	1.05	5	10	-	UL	-
		D3SBA60	600	4	108	80	150	1.05	2	10	-	UL	-
		D3SB60	600	4	108	120	150	1.05	2	10	-	UL	-
		D4SB60L	600	4	111	150	150	0.95	2	10	-	UL	-
		D3SB80	800	4	108	120	150	1.05	2	10	-	UL	-
-	D6K	D4SB80	800	4	108	150	150	0.95	2	10	-	UL	-
		D10XB60	600	10	100	120	150	1.10	5	10	-	UL	-
		D10XB60H	600	10	112	170	150	1.05	5	10	-	UL	-
		D10XB80	800	10	100	120	150	1.10	5	10	-	UL	-
		US8KB80R	800	8 *3	108	200 *3	150	1.00	4	10	-	UL	-
-	JA	US10KB80R	800	10 *3	100	150 *3	150	1.10	5	10	-	UL	-
		US15KB80R	800	15 *3	101	200 *3	-55 to 150	1.10	7.5	10	-	UL	-
		US20KB80R	800	20 *3	97	240 *3	150	1.10	10	10	-	UL	-
		US30KB80R	800	30 *3	97	350 *3	-55 to 150	1.10	15	10	-	UL	-
		US30KBV80FR	800	30 *3	126	350 *3	-55 to 175	1.05	15	5	○	UL	-
-	5S	D15JAB60V	600	15	110	200	150	1.05	7.5	10	-	UL	-
		D15JAB80V	800	15	110	200	150	1.05	7.5	10	-	UL	-
		D25JAB60V	600	25	107	350	150	1.05	12.5	10	-	UL	-
		D25JAB80V	800	25	107	350	150	1.05	12.5	10	-	UL	-
		D5SBA60	600	6	111	120	150	1.05	3	10	-	UL	-
-	5S	D5SB60	600	6	110	170	150	1.05	3	10	-	UL	-
		D6SB60L	600	6	112	170	150	1.05	3	10	-	UL	-
		D5SB80	800	6	110	170	150	1.05	3	10	-	UL	-
		D6SB80	800	6	110	170	150	1.05	3	10	-	UL	-
		D15XB60	600	15	100	200	150	1.10	7.5	10	-	UL	-
		D15XB60H	600	15	107	240	150	1.05	7.5	10	-	UL	-
		D15XB80	800	15	100	200	150	1.10	7.5	10	-	UL	-
		D15XB100	1000	15	110	200	150	1.10	7.5	10	-	UL	-
		D20XB60	600	20	87	240	150	1.10	10	10	-	UL	-
		D20XB80	800	20	87	240	150	1.10	10	10	-	UL	-
		D25XB60	600	25	98	350	150	1.05	12.5	10	-	UL	■
		D25XB80	800	25	98	350	150	1.05	12.5	10	-	UL	■
		D25XB100	1000	25	106	350	150	1.05	12.5	10	-	UL	-
-	D7	D35XB80	800	35	93	603 *3	-55 to 150	1.05	17.5	10	-	UL	-
		D50XB80	800	50	95	600	150	1.05	25	10	-	UL	-
-	JC(4pin)	D50JCB80V	800	50	94	600	150	1.05	25	10	-	UL	■







*1 : Ta *2 : Tl *3 : 60Hz ■ : Please contact us. UL : UL recognized (UL File No. E142422)

DIP (Dual In-line Package) Bridge Diode

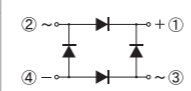



JEDEC Code JEITA Code House Name	Fig.	Type No.	Absolute Maximum Ratings					Electrical Characteristics			Halogen free	UL	Automotive
			VRRM [V]	IF (AV) [A]	Conditions Tc [°C]	IFSM [A]	Tj [°C]	Vf (max) [V]	Conditions IF [A]	IR (max) VR=VRRM [μA]			
-	D10-1	D70JHB80V	800	70	99	500	-55 to 150	1.1	35	10	-	-	-

BRIDGE DIODES



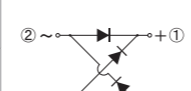

SQIP (Square In-line Package) Bridge Diodes

Package	JEDEC Code JEITA Code House Name	Fig.	I _{F(AV)} [A]	V _{RRM} [V]			Remarks
				600	800	1000	
 13.0 × 13.0 × 27.5(mm)	— — S2VB	E3	2	S2VB60			
 17.0 × 17.0 × 32.5(mm)	— — S4VB	E4	4	S4VB60			
 25.0 × 25.0 × 32.5(mm)	— — S5VB	E5	6	S5VB60			
 22.0 × 22.0 × 32.5(mm)	— — S10VB	E6	10	S10VB60			
 26.5 × 26.5 × 25.0(mm)	— — S15VB	E7	15	S15VB60			
 32.0 × 32.0 × 25.0(mm)	— — S25VB	E8	25	S25VB60	S25VB80		
 36.0 × 36.0 × 24.0(mm)	— — S50VB	E9	50	S50VB60	S50VB80		

Input/Output In-line Terminal Type

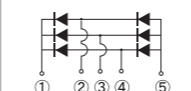
Package	JEDEC Code JEITA Code House Name	Fig.	I _{F(AV)} [A]	V _{RRM} [V]			Remarks
				600	800	1000	
 17.0 × 17.0 × 31.0(mm)	— — S3WB	E10	2.3	S3WB60			
 22.5 × 22.5 × 32.5(mm)	— — S10WB	E11	10	S10WB60			
 26.5 × 26.5 × 32.5(mm)	— — S15WB	E12	15	S15WB60			
 32.5 × 32.5 × 32.5(mm)	— — S20WB	E13	20	S20WB60	S20WB80		

3 Phase Bridge Diodes

Package	JEDEC Code JEITA Code House Name	Fig.	I _{F(AV)} [A]	V _{RRM} [V]			Remarks
				800	1200	1600	
 47.0 × 45.7 × 7.5(mm)	— — TSB(5pin)	D8	30	D30XT80			
			45	D45XT80		D45XT160	
 47.0 × 45.7 × 7.5(mm)	— — JC(5pin)		30		D30JCT120V		
			45		D45JCT120V	D45JCT160V	
 47.0 × 45.7 × 7.5(mm)	— — JF	D9	75	D75JFT80V			
 45.7 × 30.0 × 8.6(mm)	— — JH	D10-2	100	D100JHT80V	D100JHT120V	 D100JHT160V	

 : New product

SQIP (Square In-line Package) Bridge Diodes

Package		Type No.	Absolute Maximum Ratings					Electrical Characteristics			Halogen free	UL	Automotive
JEDEC Code JEITA Code House Name	Fig.		V _{RRM} [V]	I _{F(AV)} [A]	Conditions T _C [°C]	I _{FSM} [A]	T _J [°C]	V _F (max) [V]	Conditions I _F [A]	I _R (max) V _R =V _{RRM} [μA]			
— — S2VB	E3	S2VB60	600	2 *1	40	40	150	1.05	1	10	—	—	—
— — S4VB	E4	S4VB60	600	4	40	80	150	1.05	2	10	—	—	—
— — S5VB	E5	S5VB60	600	6	40	200	150	1.05	3	10	—	—	—
— — S10VB	E6	S10VB60	600	10	40	200	150	1.05	5	10	—	—	—
— — S15VB	E7	S15VB60	600	15	83 *2	200	150	1.05	7.5	10	—	—	—
— — S25VB	E8	S25VB60	600	25	85 *2	400	150	1.05	12.5	10	—	—	—
— — S25VB80		S25VB80	800	25	85 *2	400	150	1.05	12.5	10	—	—	—
— — S50VB	E9	S50VB60	600	50	95 *2	500	150	1.05	25	10	—	—	—
— — S50VB80		S50VB80	800	50	95 *2	500	150	1.05	25	10	—	—	—











*1 : Without heatsink *2 : T_C  : UL recognized (UL File No. E142422)

Input/Output In-line Terminal Type

Package		Type No.	Absolute Maximum Ratings					Electrical Characteristics			Halogen free	UL	Automotive
JEDEC Code JEITA Code House Name	Fig.		V _{RRM} [V]	I _{F(AV)} [A]	Conditions T _C [°C]	I _{FSM} [A]	T _J [°C]	V _F (max) [V]	Conditions I _F [A]	I _R (max) V _R =V _{RRM} [μA]			
— — S3WB	E10	S3WB60	600	2.3	40 *	120	150	1.05	2	10	—	—	—
— — S10WB	E11	S10WB60	600	10	74	170	150	1.05	5	10	—	—	—
— — S15WB	E12	S15WB60	600	15	77	200	150	1.05	7.5	10	—	—	—
— — S20WB	E13	S20WB60	600	20	76	500	150	1.05	10	10	—	—	—
— — S20WB80		S20WB80	800	20	76	500	150	1.05	10	10	—	—	—

* : T_a  : UL recognized (UL File No. E142422)

3 Phase Bridge Diodes



Package		Type No.	Absolute Maximum Ratings					Electrical Characteristics			Halogen free	UL	Automotive
JEDEC Code JEITA Code House Name	Fig.		V _{RRM} [V]	I _{F(AV)} [A]	Conditions T _C [°C]	I _{FSM} [A]	T _J [°C]	V _F (max) [V]	Conditions I _F [A]	I _R (max) V _R =V _{RRM} [μA]			
— — TSB(5pin)	D8	D30XT80	800	30	117	300	150	1.05	10	10	—		—
		D45XT80	800	45	101	400	150	1.05	15	10	—		—
		D45XT160	1600	45	97	360 *	150	1.05	15	100	—		—
		D30JCT120V	1200	30	116	300	150	1.05	10	10	—		—
		D45JCT120V	1200	45	99	450	150	1.05	15	10	—		—
— — JC(5pin)	D8	D45JCT160V	1600	45	97	450	150	1.05	15	10	—		—
		D9	D75JFT80V	800	75	109	400	150	1.05	25	10	—	—
— — JH	D10-2	D100JHT80V	800	100	99	500	-55 to 150	1.10	35	10	—		—
		D100JHT120V	1200	100	92	450	-55 to 150	1.17	35	10	—		—
		 D100JHT160V	1600	100	92	540	-55 to 150	1.15	35	10	—		—

 : New product * : 60Hz  : UL recognized (UL File No. E142422)

BRIDGE DIODES

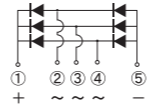

Series	Feature
S	Evenly balanced Vf and Ir
N	Low Vf, High Voltage
K	Low Vf

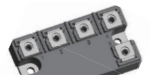
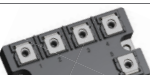
3 Phase Bridge Diodes

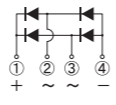

Package	JEDEC Code JEITA Code House Name	Fig.	If (AV) [A]	VRRM [V]			Remarks
				600	800	1600	
 36.0 × 36.0 × 24.0(mm)	— — SVT	E15	10	S10VT60	S10VT80		
			15	S15VT60	S15VT80		
			20	S20VT60	S20VT80		
			30	S30VT60	S30VT80	S30VT160	
 36.0 × 36.0 × 23.0(mm)	— — SVTA	E14	10	S10VTA60	S10VTA80		
			15	S15VTA60	S15VTA80		
			20	S20VTA60	S20VTA80		
 89.0 × 50.0 × 16.6(mm)	— — MG038	F7	150		MG038B150080A	MG038D150160A	
			200		MG038A200080A	MG038C200160A	
 84.5 × 46.0 × 17.0(mm)	— — MG060	F9	75		MG060B075080A	MG060E075160A	
			100		MG060C100080A		
 91.0 × 52.0 × 17.0(mm)	— — MG061	F10	100			MG061D100160A	
			150		MG061B150080A	MG061E150160A	
			200		MG061C200080A	MG061F200160A	

■ : New product ★ : Under development

High Speed Bridge Diodes (SBD)

THD (Through Hole Device)							
Package	JEDEC Code JEITA Code House Name	Fig.	If (AV) [A]	VRRM [V]			Remarks
				40	60	200	
 32.5 × 25.0 × 4.6(mm)	— — 3S	D3	4	D4SBS4	D4SBS6	D4SBN20	
			10	D10SBS4			
			15		D15XBS6		
 37.5 × 30.0 × 4.6(mm)	— — 5S	D4	6			D6SBN20	
			15			D15XBN20	
			20		D20XBS6		
			30			D30XBN20	

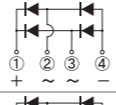
High Speed Bridge Diodes (FRD)

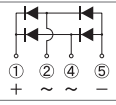
THD (Through Hole Device)							
Package	JEDEC Code JEITA Code House Name	Fig.	If (AV) [A]	VRRM [V]			Remarks
				200	400	1000	
 32.5 × 25.0 × 4.6(mm)	— — 3S	D3	4	D4SBL20U			
 47.0 × 45.7 × 7.5(mm)	— — JC(4pin)	D7	30			D30JCB100K	

3 Phase Bridge Diodes

Package		Type No.	Absolute Maximum Ratings				Electrical Characteristics			Halogen free	UL	Automotive	
JEDEC Code JEITA Code House Name	Fig.		VRRM [V]	If (AV) [A]	Conditions Tc [°C]	IFSM [A]	Tj [°C]	Vf (max) [V]	Conditions If [A]				Ir (max) Vr=VRRM [μA]
— — SVT	E15	S10VT60	600	10	137	170	150	1.05	3.5	10	—	—	—
		S10VT80	800	10	137	150	150	1.05	3.5	10	—	—	—
		S15VT60	600	15	132	200	150	1.05	5	10	—	—	—
		S15VT80	800	15	132	200	150	1.05	5	10	—	—	—
		S20VT60	600	20	128	300	150	1.05	7	10	—	—	—
		S20VT80	800	20	128	300	150	1.05	7	10	—	—	—
		S30VT60	600	30	121	400	150	1.05	10	10	—	—	—
		S30VT80	800	30	121	400	150	1.05	10	10	—	UL	—
		S30VT160	1600	30	116	350	150	1.05	10	100	—	—	—
		— — SVTA	E14	S10VTA60	600	10	137	170	150	1.05	3.5	10	—
S10VTA80	800			10	137	150	150	1.05	3.5	10	—	—	—
S15VTA60	600			15	132	200	150	1.05	5	10	—	—	—
S15VTA80	800			15	132	200	150	1.05	5	10	—	—	—
S20VTA60	600			20	128	300	150	1.05	7	10	—	—	—
S20VTA80	800			20	128	300	150	1.05	7	10	—	—	—
S30VTA60	600			30	121	400	150	1.05	10	10	—	—	—
S30VTA80	800			30	121	400	150	1.05	10	10	—	—	—
S30VTA160	1600			30	116	350	150	1.05	10	100	—	—	—
— — MG038	F7			MG038B150080A	800	150	125	1650	150	1.05	50	10	○
		MG038D150160A	1600	150	125	1600	150	1.05	50	10	○	UL	—
		MG038A200080A	800	200	125	1950	150	1.05	67	10	○	UL	—
		MG038C200160A	1600	200	125	2000	150	1.05	67	10	○	UL	—
— — MG060	F9	MG060B075080A	800	75	125	TBD	150	TBD	75	10	○	to be certified	—
		MG060E075160A	1600	75	125	TBD	150	TBD	75	10	○	to be certified	—
		MG060C100080A	800	100	125	TBD	150	TBD	100	10	○	to be certified	—
— — MG061	F10	MG061D100160A	1600	100	125	TBD	150	TBD	100	10	○	to be certified	—
		MG061B150080A	800	150	125	TBD	150	TBD	150	10	○	to be certified	—
		MG061E150160A	1600	150	125	TBD	150	TBD	150	10	○	to be certified	—
		MG061C200080A	800	200	125	TBD	150	TBD	200	10	○	to be certified	—
			200	200	125	TBD	150	TBD	200	10	○	to be certified	—

■ : New product ★ : Under development UL : UL recognized (UL File No. E142422)

High Speed Bridge Diodes (SBD)

THD (Through Hole Device)														
Package		Type No.	Absolute Maximum Ratings				Electrical Characteristics			Halogen free	UL	Automotive	Remarks	
JEDEC Code JEITA Code House Name	Fig.		VRRM [V]	If (AV) [A]	Conditions Tc [°C]	IFSM [A]	Tj [°C]	Vf (max) [V]	Conditions If [A]					Ir (max) Vr=VRRM [μA]
— — 3S	D3	D4SBS4	40	4	116	60	150	0.55	2	2mA	—	—	—	S series
		D4SBS6	60	4	114	60	150	0.62	2	2mA	—	—	—	S series
		D4SBN20	200	4	103	60	150	0.90	2	1.5	—	—	—	N series
		D10SBS4	40	10	67	100	150	0.55	5	3.5mA	—	—	—	S series
		D15XBS6	60	15	59	150	150	0.63	7.5	6.0mA	—	—	—	S series
— — 5S	D4	D6SBN20	200	6	110	120	150	0.90	3	2	—	—	—	N series
		D15XBN20	200	15	106	200	150	0.90	7.5	5	—	—	—	N series
		D20XBS6	60	20	100	200	150	0.63	10	8.0mA	—	—	—	S series
		D30XBN20	200	30	91	350	150	0.90	15	10	—	—	—	N series

High Speed Bridge Diodes (FRD)

THD (Through Hole Device)														
Package		Type No.	Absolute Maximum Ratings				Electrical Characteristics			Halogen free	UL	Automotive	Remarks	
JEDEC Code JEITA Code House Name	Fig.		VRRM [V]	If (AV) [A]	Conditions Tc [°C]	IFSM [A]	Tj [°C]	Vf (max) [V]	Conditions If [A]					Ir (max) Vr=VRRM [μA]
— — 3S	D3	D4SBL20U	200	4	108	80	150	0.98	2	10	—	—	—	
— — JC(4pin)	D7	D30JCB100K	1000	30	90	450	150	1.90	15	10	—	UL	○	K series

UL : UL recognized (UL File No. E142422)

BRIDGE DIODES

Low Vf Bridge Diodes

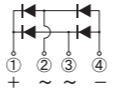
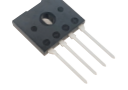
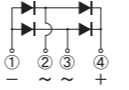

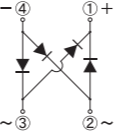

THD (Through Hole Device)							
Package	JEDEC Code JEITA Code House Name	Fig.	I _{F(AV)} [A]	V _{RRM} [V]			Remarks
				600	800	1000	
 37.5 × 30.0 × 4.6(mm)	— 5S	D4	15	LL15XB60			
			25	LL25XB60 LK25XB60			
 37.1 × 22.1 × 3.45(mm)	— D6K	D11	25	LM25KBV60FR			
			30	LM30KBV60FR			

■ : New product ★ : Under development

Low Noise Bridge Diodes

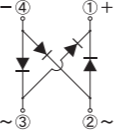
Surface Mount							
Package	JEDEC Code JEITA Code House Name	Fig.	I _{F(AV)} [A]	V _{RRM} [V]			Remarks
				600	800	1000	
 10.6 × 10.2 × 3.1(mm)	— 1W	C8	1.1	LN1WBA60			

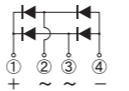
THD (Through Hole Device)

Package	JEDEC Code JEITA Code House Name	Fig.	I _{F(AV)} [A]	V _{RRM} [V]			Remarks
				600	800	1000	
 6.2 × 10.2 × 3.0(mm)	— 1W	C9	1.1	LN1WBA60			
 32.5 × 25.0 × 4.6(mm)	— 3S	D3	4	LN4SB60			
 37.5 × 30.0 × 4.6(mm)	— 5S	D4	6	LN6SB60			
			15	LN15XB60 LN15XB60H			
			25	LN25XB60			

Low Vf Bridge Diodes

THD (Through Hole Device)														
Package		Type No.	Absolute Maximum Ratings					Electrical Characteristics				Halogen free	UL	Automotive
JEDEC Code JEITA Code House Name	Fig.		V _{RRM} [V]	I _{F(AV)} [A]	Conditions T _C [°C]	I _{FSM} [A]	T _J [°C]	V _F (max) [V]	Conditions I _F [A]	I _R (max) V _R =V _{RRM} [μA]	t _{rr} (max) [μs]			
— 5S	D4	LL15XB60	600	15	124	200	150	0.90	7.5	10	3	—	UL	—
		LL25XB60	600	25	113	300	150	0.92	12.5	10	3	—	UL	■
		LK25XB60	600	25	114	603 *	-55 to 150	0.95	12.5	10	5	—	UL	—
— D6K	D11	LM25KBV60FR	600	25	115	350 *	-55 to 150	0.91	12.5	10	3	○	UL	—
		LM30KBV60FR	600	30	106	350 *	-55 to 150	0.92	15	10	3	○	UL	—

■ : New product ★ : Under development * : 60Hz ■ : Please contact us. UL : UL recognized (UL File No. E142422)

Low Noise Bridge Diodes

Surface Mount-THD (Through Hole Device)															
Package		Type No.	Absolute Maximum Ratings					Electrical Characteristics				UL	Halogen free	Automotive	Remarks
JEDEC Code JEITA Code House Name	Fig.		V _{RRM} [V]	I _{F(AV)} [A]	Conditions T _C [°C]	I _{FSM} [A]	T _J [°C]	V _F (max) [V]	Conditions I _F [A]	I _R (max) V _R =V _{RRM} [μA]	t _{rr} (max) [μs]				
— 1W	C8(SMD) C9(DIP)	LN1WBA60	600	1.1	25 *	50	150	1.00	0.55	10	5	—	—	—	SMD-7072 DIP-7101
— 3S	D3	LN4SB60	600	4	111	150	150	0.95	2	10	5	UL	—	—	
— 5S	D4	LN6SB60	600	6	111	170	150	1.05	3	10	5	UL	—	—	
		LN15XB60	600	15	100	200	150	1.10	7.5	10	5	—	—	—	
		LN15XB60H	600	15	106	290	150	1.05	7.5	10	5	—	—	—	
		LN25XB60	600	25	85	350	150	1.05	12.5	10	5	—	—	—	

* : T_a UL : UL recognized (UL File No. E142422)

SCHOTTKY BARRIER DIODES

Schottky Barrier Diodes are diodes using a barrier at the junction of a metal and the semiconductor. These are very suitable rectification devices featuring high speed and a low VF diode.

Series	Feature
S	Evenly balanced Vf and Ir
M	Evenly balanced Low Vf and Ir
N	High Voltage
H	Ultra Low Vf
J	Low Ir
SL	Ultra Low Ir, Tj=175°C guaranteed
Y	Evenly balanced Vf and Low Ir
W	SiCSBD,Ultra High Recovery Speed,Low Noise

Single

Package	JEDEC Code JEITA Code House Name	Fig.	If (AV) [A]	VRRM[V]							Remarks
				30	40	45	60	80	100	150	
	DO-219AB similar SC-109 G1F	B1-1	1	DG1M3 DG1H3	DG1S4		DG1S6		DG1J10A		
			1.4						DG1N15A		
			1.5	DG1M3A DG1H3A			DG1S6A				
	DO-219AA similar - M1F	B2	1.2				M1FS6				
			1.33		M1FS4						
			1.5		M1FJ4						
			1.7	M1FH3							
			3	M1FM3							
	DO-214AC - 1F	B3-1	1						D1FJ10		
			1.1		D1FS4		D1FS6				
			1.5		D1FS4A						
			2		D1FT4 D1FJ4		D1FT6	D1FJ8	D1FT10		
			2.5				D1FS6A				
			3	D1FH3	D1FT4A		D1FT6A	D1FJ8A	D1FT10A	D1FT15A	
	SC-110B CE	B5-1	3		D3CE4S		D3CE6S		D3CE15ST		
			5		D5CE4S						
	DO-214AA similar - M2F	B6	6	M2FH3 M2FM3							
	- - 2F	B9-1	1.5				D2FS6				
			1.6		D2FS4						
			2.6		D3FS4A						
			3				D3FS6		D3FJ10		
	SC-63 E-pack	G1-2	3		DE3S4M		DE3S6M				
			5		DE5S4M		DE5S6M				
			10	DE10S3L							
	TO-277A similar - FY	G4	5		D5FY4R5ST D5FY4R5SY	D5FY6ST D5FY6SY		D5FY10ST D5FY10SY	D5FY15ST	D5FY20SN	
			10		D10FY4R5ST D10FY4R5SY	D10FY6ST D10FY6SY		D10FY10ST D10FY10SY	D10FY15ST		
			15		D15FY4R5ST D15FY4R5SY	D15FY6ST D15FY6SY		D15FY10ST D15FY10SY	D15FY15ST		
	TO-252AA similar - FR	G5	15		D15FR4ST						
			20		D20FR4ST		D20FR4R5S				





■ : New product

Single



Surface Mount		Package		Absolute Maximum Ratings						Electrical Characteristics				Halogen free	Based on AEC-Q101	Automotive	Series
JEDEC Code JEITA Code House Name	Fig.	Type No.	VRRM [V]	If (AV) [A]	Conditions Tc [°C]	IfSM [A]	Tj [°C]	Vf (max) [V]	Conditions If [A]	Ir (max) Vr=VRRM [mA]	Ct (typ) [pF]						
DO-219AB similar SC-109 G1F	B1-1	DG1M3	30	1	27 *1	20	150	0.46	0.7	0.05	36	-	○	○	M series		
		DG1H3	30	1	113 *2	20	125	0.36	0.7	1	37	-	○	○	H series		
		DG1S4	40	1	36 *1	30	150	0.55	0.7	0.8	37	-	○	○	S series		
		DG1S6	60	1	128 *2	30	150	0.58	0.7	1	32	-	○	○	S series		
		DG1J10A	100	1	125 *2	30	150	0.82	1	0.1	43	-	○	○	J series		
		DG1N15A	150	1.4	65 *1	30	150	0.88	1.4	0.05	32	-	○	○	N series		
		DG1M3A	30	1.5	37 *1	30	150	0.46	1.5	0.05	70	-	○	○	M series		
		DG1H3A	30	1.5	107 *2	30	125	0.36	1.5	1	70	-	○	○	H series		
		DG1S6A	60	1.5	122 *2	40	150	0.53	1	0.05	43	-	○	○	S series		
		M1FS6	60	1.2	25 *1	40	150	0.58	1.1	1	53	-	○	○	S series		
DO-219AA similar - M1F	B2	M1FS4	40	1.33	25 *1	30	150	0.55	1.1	0.8	50	-	○	○	S series		
		M1FJ4	40	1.5	31 *1	30	150	0.63	1.5	0.05	65	-	○	○	J series		
		M1FH3	30	1.7	25 *1	30	-55 to 125	0.36	1.5	1	80	-	-	-	H series		
		M1FM3	30	3	100	30	150	0.46	1.5	0.05	80	-	○	○	M series		
		D1FJ10	100	1	52 *1	50	150	0.72	1	0.2	63	-	○	○	J series		
		D1FS4	40	1.1	51 *1	30	150	0.55	1.1	1	65	-	○	○	S series		
		D1FS6	60	1.1	38 *1	40	150	0.58	1.1	1	50	-	○	○	S series		
		D1FS4A	40	1.5	28 *1	60	150	0.48	1.5	2	95	-	○	○	S series		
		D1FT4	40	2	143 *2	60	175	0.74	2	5μA	63	-	○	○	SL series		
		D1FJ4	40	2	117 *2	50	150	0.61	2	0.2	96	-	○	○	J series		
DO-214AC - 1F	B3-1	D1FT6	60	2	141 *2	60	175	0.78	2	5μA	53	-	○	○	SL series		
		D1FJ8	80	2	110	30	150	0.74	1.5	0.2	40	-	○	○	Y series		
		D1FT10	100	2	136 *2	50	175	0.86	2	5μA	40	-	○	○	SL series		
		D1FS6A	60	2.5	103 *2	60	150	0.57	2.5	0.2	80	-	○	○	S series		
		D1FH3	30	3	95	60	125	0.36	3	2	130	-	-	-	■		
		D1FT4A	40	3	127 *2	90	175	0.74	3	8μA	93	-	○	○	SL series		
		D1FT6A	60	3	125 *2	90	175	0.78	3	8μA	78	-	○	○	SL series		
		D1FJ8A	80	3	100	30	150	0.74	3	0.4	70	-	-	-	Y series		
		D1FT10A	100	3	116 *2	60	175	0.86	3	8μA	60	-	○	○	SL series		
		D1FT15A	150	3	116 *2	60	175	0.88	3	8μA	52	-	○	○	SL series		
SC-110B CE	B5-1	D1FM3	30	5	83	90	150	0.46	3	0.1	130	-	○	○	M series		
		D3CE4S	40	3	106 *2	80	150	0.52	3	0.3	97	-	○	○	S series		
		D3CE6S	60	3	112 *2	100	150	0.58	3	0.3	110	-	○	○	S series		
		D3CE15ST	150	3	136 *2	80	175	0.88	3	8μA	52	-	○	○	SL series		
DO-214AA similar - M2F	B6	D5CE4S	40	5	94 *2	120	-55 to 150	0.52	5	0.5	157	-	-	-	○		
		M2FH3	30	6	70	110	125	0.36	6	4	240	-	-	-	H series		
DO-214AA similar - M2F	B6	M2FM3	30	6	99	120	150	0.46	6	0.2	240	-	○	○	M series		
SC-63 E-pack	G1-2	D2FS6	60	1.5	31 *1	60	150	0.58	2	2	120	-	-	-	○		
		D2FS4	40	1.6	34 *1	60	150	0.55	1.6	2.5	150	-	-	-	○		
		D3FS4A	40	2.6	34 *1	150	150	0.45	2.6	5	340	-	○	○	S series		
		D3FS6	60	3	87 *2	80	150	0.58	3	2.5	130	-	-	-	○		
SC-63 E-pack	G1-4	D3FJ10	100	3	92 *2	100	150	0.74	3	0.4	143	-	-	-	○		
		DE3S4M	40	3	121	70	150	0.55	3	2.5	150	-	-	-	○		
		DE3S6M	60	3	117	80	150	0.58	3	2.5	130	-	-	-	○		
		DE5S4M	40	5	101	80	150	0.55	5	3.5	180	-	-	-	○		
		DE5S6M	60	5	96	90	150	0.58	5	4.5	200	-	-	-	○		
		DE10S3L	30	10	124	250	150	0.45	8	10	640	-	-	-	S series		
		D5FY4R5ST	45	5	165 *2	240	-55 to 175	0.74	5	15μA	187	○	○	○	SL series		
		D5FY4R5SY	45	5	138 *2	220	-55 to 150	0.59	5	0.2	155	○	○	○	Y series		
		D5FY6ST	60	5	164 *2	210	-55 to 175	0.78	5	15μA	148	○	○	○	SL series		
		D5FY6SY	60	5	138 *2	210	-55 to 150	0.67	5	0.2	170	○	○	○	Y series		
TO-277A similar - FY	G4	D5FY10ST	100	5	162 *2	210	-55 to 175	0.86	5	15μA	104	○	○	○	SL series		
		D5FY10SY	100	5	132 *2	130	-55 to 150	0.8	5	0.2	141	○	○	○	Y series		
		D5FY15ST	150	5	162 *2	210	-55 to 175	0.88	5	15μA	92	○	○	○	SL series		
		D5FY20SN	200	5	163 *2	210	-55 to 175	0.87	5	5μA	111	○	○	○	SL series		
		D10FY4R5ST	45	10	155 *2	250	-55 to 175	0.74	10	30μA	330	○	○	○	SL series		
		D10FY4R5SY	45	10	126 *2	290	-55 to 150	0.59	10	0.4	302	○	○	○	Y series		
		D10FY6ST	60	10	154 *2	230	-55 to 175	0.78	10	30μA	263	○	○	○	SL series		
		D10FY6SY	60	10	127 *2	250	-55 to 150	0.67	10	0.4	262	○	○	○	Y series		
		D10FY10ST	100	10	152 *2	230	-55 to 175	0.86	10	30μA	185	○	○	○	SL series		
		D10FY10SY	100	10	118 *2	260	-55 to 150	0.8	10	0.4	253	○	○	○	Y series		
		D10FY15ST	150	10	149 *2	230	-55 to 175	0.88	10	30μA	159	○	○	○	SL series		
		D15FY4R5ST	45	15	145 *2	270	-55 to 175	0.74	15	40μA	398	○	○	○	SL series		
		D15FY4R5SY	45	15	116 *2	310	-55 to 150	0.59	15	0.5	410	○	○	○	Y series		
		D15FY6ST	60	15	143 *2	250	-55 to 175	0.78	15	40μA	345	○	○	○	SL series		
		D15FY6SY	60	15	117 *2	280	-55 to 150	0.67	15	0.5	345	○	○	○	Y series		
		D15FY10ST	100	15	141 *2	250	-55 to 175	0.86	15	40μA	242	○	○	○	SL series		
		D15FY10SY	100	15	114 *2	280	-55 to 150	0.83	15	0.5	297	○	○	○	Y series		

SCHOTTKY BARRIER DIODES

Single

Package	JEDEC Code JEITA Code House Name	Fig.	I _{F(AV)} [A]	V _{RRM} [V]		Remarks
				40	60	
 3.0 × φ 2.6(mm)	— — AX057	A1	1	D1NS4	D1NS6	
 5.0 × φ 4.0(mm)	— — AX078	A4-1	2	D2S4M	D2S6M	
 7.0 × φ 4.4(mm)	— — AX14	A7	3	D3S4M	D3S6M	

Two Terminal Type

Package	JEDEC Code JEITA Code House Name	Fig.	I _{F(AV)} [A]	V _{RRM} [V]				Remarks
				40	60	90	150	
 28.5 × 10.0 × 4.5(mm)	— SC-91 FTO-220G	J4	5	SG5S4M	SG5S6M	SG5S9M		

Three Terminal Type

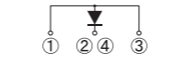
Package	JEDEC Code JEITA Code House Name	Fig.	I _{F(AV)} [A]	V _{RRM} [V]				Remarks
				40	60	90	150	
 41.0 × 16.0 × 5.0(mm)	TO-247AD — MTO-3PV	K7-2	40				S40T15V	
			90				S90T15V	

Single

Axial		Type No.	Absolute Maximum Ratings					Electrical Characteristics				Halogen free	Based on AEC-Q101	Automotive	Series
JEDEC Code JEITA Code House Name	Fig.		V _{RRM} [V]	I _{F(AV)} [A]	Conditions T _a [°C]	I _{FSM} [A]	T _j [°C]	V _F (max) [V]	Conditions I _F [A]	I _R (max) V _R =V _{RRM} [mA]	C _t (typ) [pF]				
— — AX057	A1	D1NS4	40	1	59	30	150	0.55	1	0.8	50	—	—	—	S series
— — AX078	A4-1	D2S4M	40	2	122 *1	60	150	0.55	2	2	95	—	—	—	S series
— — AX14	A7	D3S4M	40	3	63	80	150	0.55	3	3.5	150	—	—	—	S series
— — AX14	A7	D3S6M	60	3	133 *1	80	150	0.58	3	2.5	130	—	—	—	S series

*1 : Tl

Two Terminal Type







Two Terminal Type		Type No.	Absolute Maximum Ratings					Electrical Characteristics				Halogen free	Based on AEC-Q101	Automotive	Series
JEDEC Code JEITA Code House Name	Fig.		V _{RRM} [V]	I _{F(AV)} [A]	Conditions T _c [°C]	I _{FSM} [A]	T _j [°C]	V _F (max) [V]	Conditions I _F [A]	I _R (max) V _R =V _{RRM} [mA]	C _t (typ) [pF]				
— SC-91 FTO-220G	J4	SG5S4M	40	5	131	150	150	0.52	5	0.5	157	—	—	—	S series
		SG5S6M	60	5	130	120	150	0.56	5	0.5	165	—	—	—	S series
		SG5S9M	90	5	124	90	150	0.75	5	0.5	140	—	—	—	S series

Three Terminal Type

Three Terminal Type		Type No.	Absolute Maximum Ratings					Electrical Characteristics				Halogen free	Based on AEC-Q101	Automotive	Series
JEDEC Code JEITA Code House Name	Fig.		V _{RRM} [V]	I _{F(AV)} [A]	Conditions T _c [°C]	I _{FSM} [A]	T _j [°C]	V _F (max) [V]	Conditions I _F [A]	I _R (max) V _R =V _{RRM} [mA]	C _t (typ) [pF]				
TO-247AD — MTO-3PV	K7-2	S40T15V	150	40	131	700	150	0.92	40	0.12	595	—	—	○	N series
		S90T15V	150	90	122	1400	150	0.95	90	0.35	1690	—	—	○	N series

SCHOTTKY BARRIER DIODES

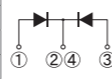
Center Tap, Common Cathode

Surface Mount											Remarks	
Package	JEDEC Code JEITA Code House Name	Fig.	IF (AV) [A]	VRRM[V]						Remarks		
				30	40	60	90	100	120			150
 9.5 × 6.6 × 2.65(mm)	— SC-63 E-pack	G1-1	5	DE5SC3ML	DE5SC4M	DE5SC6M						
			10	DE10SC3L	DE10SC4							
 9.5 × 6.6 × 2.65(mm)	TO-252AB similar SC-63 FE	G3-1	5	 D5FEC3SH								
			6		D6FEC4ST			D6FEC10ST	D6FEC12ST	D6FEC15ST		
 13.2 × 10.2 × 4.7(mm)	— SC-83 similar STO-220	H1-1	10		DF10SC4M	DF10SC6	DF10SC9				DF10NC15	
			15		DF15SC4M			DF15JC10			DF15NC15	
			20		DF20SC4M		DF20SC9M	DF20JC10			DF20NC15	
			25				DF25SC6M					
			30	DF30SC3ML	DF30JC4 DF30SC4M	DF30JC6		DF30JC10		DF30NC15		
 13.2 × 10.2 × 4.6(mm)	— SC-83 similar FD	H2-2	10						D10FDC10ST			
			20						D20FDC10ST		D20FDC15ST	
			30		D30FDC4S				D30FDC10ST		D30FDC15ST	
			40						D40FDC10ST		D40FDC15ST	

 : New product

Center Tap, Common Cathode





Surface Mount																			
JEDEC Code JEITA Code House Name	Package	Fig.	Type No.	Absolute Maximum Ratings					Electrical Characteristics					Halogen free	Based on AEC-Q101	Automotive	Series		
				VRRM [V]	IF (AV) [A]	Conditions Tc [°C]	IFSM [A]	Tj [°C]	VF (max) [V]	Conditions IF [A]	Ir (max) VR=VRRM [mA]	Ct (typ) [pF]							
— SC-63 E-pack	G1-1		DE5SC3ML	30	5	110	90	150	0.45	2.5	3.5	190	—	—	■	S series			
			DE5SC4M	40	5	101	80	150	0.55	2.5	3.5	150	—	—	■	S series			
			DE5SC6M	60	5	92	80	150	0.58	2.5	2.5	130	—	—	■	S series			
			DE10SC3L	30	10	124	100	150	0.45	4	5	290	—	—	■	S series			
TO-252AB similar SC-63 FE	G3-1		 D5FEC3SH	30	5	110	100	-55 to 125	0.4	2.5	1.3	91	—	—	—	H series			
			D6FEC4ST	40	6	158	90	175	0.74	3	8μA	93	—	○	○	SL series			
			D6FEC10ST	100	6	154	100	175	0.86	3	8μA	60	—	○	○	SL series			
			D6FEC12ST	120	6	154	100	175	0.87	3	8μA	60	—	○	○	SL series			
			D6FEC15ST	150	6	154	100	175	0.88	3	8μA	52	—	○	○	SL series			
			DF10SC4M	40	10	125	100	150	0.55	5	3.5	180	—	—	—	S series			
			DF10SC6	60	10	132	150	150	0.58	5	4.5	260	—	—	—	S series			
			DF10SC9	90	10	131	150	150	0.75	5	3	185	—	—	—	S series			
			DF10NC15	150	10	123	100	150	0.88	5	0.2	110	—	—	—	N series			
			DF15SC4M	40	15	129	150	150	0.55	7.5	5	340	—	—	—	S series			
— SC-83 similar STO-220	H1-1		DF15JC10	100	15	126	150	150	0.86	7.5	0.6	200	—	—	—	J series			
			DF15NC15	150	15	126	150	150	0.88	7.5	0.3	155	—	—	—	N series			
			DF20SC4M	40	20	122	230	150	0.55	10	7.5	390	—	—	—	S series			
			DF20SC9M	90	20	111	200	150	0.75	10	10	370	—	—	—	S series			
			DF20JC10	100	20	121	200	150	0.86	10	0.7	260	—	—	—	J series			
			DF20NC15	150	20	121	200	150	0.88	10	0.4	200	—	—	—	N series			
			DF25SC6M	60	25	115	300	150	0.58	12.5	10	490	—	—	—	S series			
			DF30SC3ML	30	30	119	350	150	0.48	15	10	820	—	—	—	S series			
			DF30JC4	40	30	115	250	150	0.61	15	0.7	560	—	—	—	J series			
			DF30SC4M	40	30	112	360	150	0.55	15	10	590	—	—	—	S series			
			DF30JC6	60	30	108	250	150	0.69	15	0.7	490	—	—	—	J series			
			DF30JC10	100	30	116	300	150	0.86	15	1	390	—	—	—	J series			
			DF30NC15	150	30	115	300	150	0.88	15	0.5	300	—	—	—	N series			
			DF40SC3L	30	40	112	400	150	0.45	15	17	1200	—	—	—	S series			
			DF40SC4	40	40	106	350	150	0.55	20	14	860	—	—	—	S series			
			— SC-83 similar FD	H2-2		D10FDC10ST	100	10	158	150	175	0.86	5	15μA	104	—	○	○	SL series
						D20FDC10ST	100	20	119	250	150	0.86	10	30μA	185	—	○	○	N series
						D20FDC15ST	150	20	118	250	150	0.88	10	30μA	159	—	—	○	N series
D30FDC4S	40	30				114	300	150	0.55	15	1.5	415	—	○	○	S series			
D30FDC10ST	100	30				108	300	150	0.86	15	40μA	242	—	—	○	N series			
D30FDC15ST	150	30				107	300	150	0.88	15	40μA	209	—	—	○	N series			
D40FDC10ST	100	40				105	400	150	0.86	20	60μA	360	—	—	—	■	N series		
D40FDC15ST	150	40				103	400	150	0.88	20	60μA	315	—	—	—	■	N series		

 : New product  : Please contact us.

SCHOTTKY BARRIER DIODES

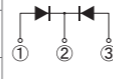
SCHOTTKY BARRIER DIODES

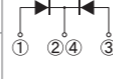
Center Tap, Common Cathode

Three Terminal Type													Remarks		
Package	JEDEC Code JEITA Code House Name	Fig.	IF (AV) [A]	VRRM[V]											
				15	30	40	60	90	100	120	150	650			
 28.5 × 10.0 × 4.5(mm)	SC-91 FTO-220G	J9	8			SG8SC4M									
			10		SG10SC3LM	SG10SC4M	SG10SC6M	SG10SC9M				SG10TC15M			
			15			SG15SC4M	SG15SC6M								
			20		SG20SC3LM	SG20SC4M	SG20JC6M SG20SC6M	SG20SC9M	SG20TC10M	SG20TC12M	SG20TC15M				
			30		SG30SC3LM	SG30SC4M	SG30JC6M SG30SC6M		SG30TC10M	SG30TC12M	SG30TC15M				
 41.0 × 16.0 × 5.0(mm)	TO-247AD MTO-3PT	K5-2	20												
			30			S30SC4MT	S30SC6MT				S30TC15T				
			40	S40HC1R5T											
			60	S60HC1R5T	S60HC3T S60SC3LT	S60SC4MT	S60SC6MT								
			20											 S20SC65WV	
 41.0 × 16.0 × 5.0(mm)	TO-247AD MTO-3PV	K7-1	60												
											S60JC10V				

 : New product

Center Tap, Common Cathode

Three Terminal Type													Halogen free	Based on AEC-Q101	Automotive	Series
JEDEC Code JEITA Code House Name	Fig.	Type No.	Absolute Maximum Ratings					Electrical Characteristics								
			VRRM [V]	IF (AV) [A]	Conditions Tc [°C]	IFSM [A]	Tj [°C]	Vf (max) [V]	Conditions IF [A]	Ir (max) VR=VRRM [mA]	Ct (typ) [pF]					
SC-91 FTO-220G	J9	SG8SC4M	40	8	155	80	175	0.56	4.0	0.3	100	-	-	-	S series	
		SG10SC3LM	30	10	136	150	150	0.45	4.0	5	310	-	-	-	S series	
		SG10SC4M	40	10	150	150	175	0.52	5.0	0.5	157	-	-	-	S series	
		SG10SC6M	60	10	145	140	175	0.56	5.0	0.5	165	-	-	-	S series	
		SG10SC9M	90	10	139	150	175	0.75	5.0	0.5	140	-	-	-	S series	
		SG10TC15M	150	10	153	120	175	0.88	5.0	15μA	92	-	-	-	SL series	
		SG15SC4M	40	15	117	150	150	0.52	7.5	0.8	230	-	-	-	S series	
		SG15SC6M	60	15	113	180	150	0.61	7.5	0.6	185	-	-	-	S series	
		SG20SC3LM	30	20	124	250	150	0.45	8.0	9	570	-	-	-	S series	
		SG20SC4M	40	20	115	200	150	0.52	10.0	1.1	315	-	-	-	S series	
		SG20JC6M	60	20	106	200	150	0.69	10.0	0.1	250	-	-	-	J series	
		SG20SC6M	60	20	107	200	150	0.61	10.0	0.8	250	-	-	-	S series	
		SG20SC9M	90	20	112	200	150	0.75	10.0	1	245	-	-	-	S series	
		SG20TC10M	100	20	140	200	175	0.86	10.0	30μA	185	-	-	-	SL series	
		SG20TC12M	120	20	137	200	175	0.87	10.0	30μA	175	-	-	-	SL series	
		SG20TC15M	150	20	136	200	175	0.88	10.0	30μA	159	-	-	-	SL series	
		SG30SC3LM	30	30	117	350	150	0.45	12.5	15	960	-	-	-	M series	
		SG30SC4M	40	30	101	300	150	0.55	15.0	1.5	415	-	-	-	S series	
		SG30JC6M	60	30	90	250	150	0.69	15.0	0.15	325	-	-	-	J series	
		SG30SC6M	60	30	100	300	150	0.61	15.0	1.2	385	-	-	-	S series	
		SG30TC10M	100	30	126	300	175	0.86	15.0	40μA	242	-	-	-	SL series	
		SG30TC12M	120	30	122	300	175	0.87	15.0	40μA	228	-	-	-	SL series	
		SG30TC15M	150	30	122	300	175	0.88	15.0	40μA	209	-	-	-	SL series	
		SG40TC10M	100	40	116	350	175	0.86	20.0	60μA	362	-	-	-	SL series	
		SG40TC12M	120	40	112	350	175	0.87	20.0	60μA	336	-	-	-	SL series	
TO-247AD MTO-3PT	K5-2	S20SC9MT	90	20	136	200	150	0.75	10.0	1	245	-	-	-	S series	
		S30SC4MT	40	30	132	300	150	0.55	15.0	1.5	410	-	-	-	S series	
		S30SC6MT	60	30	129	300	150	0.61	15.0	1.2	385	-	-	-	S series	
		S30TC15T	150	30	128	300	150	0.88	15.0	40μA	209	-	-	-	N series	
		S40HC1R5T	15	40	111	450	125	0.41	20.0	10	960	-	-	-	H series	
		S60HC1R5T	15	60	110	600	125	0.41	30.0	15	1400	-	-	-	H series	
		S60HC3T	30	60	112	650	125	0.40	30.0	20	1100	-	-	-	H series	
		S60SC3LT	30	60	138	650	150	0.48	30.0	25	1600	-	-	-	S series	
		S60SC4MT	40	60	127	500	150	0.55	30.0	3	790	-	-	-	S series	
		S60SC6MT	60	60	121	470	150	0.67	30.0	2	640	-	-	-	S series	
TO-247AD MTO-3PV	K7-1	S60JC10V	100	60	118	500	150	0.95	30.0	0.2	695	-	-	○	J series	
		 S20SC65WV	650	20	125	55	-55 to 175	1.9	10	0.1	170	-	-	-	W series	



 : New product

SCHOTTKY BARRIER DIODES

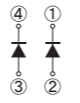
Array

Surface Mount						
Package	JEDEC Code JEITA Code House Name	Fig.	I _{F(AV)} [A]	V _{RRM} [V]		Remarks
				40	60	
 7.0 × 4.7 × 2.6(mm)	TO-269AA — 1Z	C2-2	1.2	S1ZAS4		

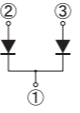
Diode Module

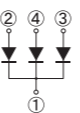
Diode Module						
Package	JEDEC Code JEITA Code House Name	Fig.	I _{F(AV)} [A]	V _{RRM} [V]		Remarks
				40	60	
 43.0 × 27.0 × 21.0(mm)	— — Module	F1	120	D120SC4M	D120SC6M	
			240	D240SC4M	D240SC6M	
 43.0 × 27.0 × 21.0(mm)		F3-1	180	D180SC4M	D180SC6M	
				360	D360SC4M	

Array

Surface Mount															
Package		Type No.	Absolute Maximum Ratings					Electrical Characteristics				Halogen free	Based on AEC-Q101	Automotive	Series
JEDEC Code JEITA Code House Name	Fig.		V _{RRM} [V]	I _{F(AV)} [A]	Conditions T _a [°C]	I _{FSM} [A]	T _j [°C]	V _F (max) [V]	Conditions I _F [A]	I _R (max) V _R =V _{RRM} [mA]	C _t (typ) [pF]				
TO-269AA — 1Z	C2-2	S1ZAS4	40	1.2	47	40	150	0.55	1	1	65	—	—	—	S series

Diode Module

Diode Module															
Package		Type No.	Absolute Maximum Ratings					Electrical Characteristics				Halogen free	Based on AEC-Q101	Automotive	Series
JEDEC Code JEITA Code House Name	Fig.		V _{RRM} [V]	I _{F(AV)} [A]	Conditions T _c [°C]	I _{FSM} [A]	T _j [°C]	V _F (max) [V]	Conditions I _F [A]	I _R (max) V _R =V _{RRM} [mA]	C _t (typ) [pF]				
— — Module	F1	D120SC4M	40	120	90	800	125	0.58	60	40	2.1	—	—	—	S series
		D120SC6M	60	120	85	800	125	0.67	60	40	2.2	—	—	—	S series
		D240SC4M	40	240	77	1600	125	0.6	120	80	4.2	—	—	—	S series
	F3-1	D240SC6M	60	240	71	1600	125	0.67	120	80	4.4	—	—	—	S series
		D180SC4M	40	180	83	800	125	0.58	60	40	2.1	—	—	—	S series
		D180SC6M	60	180	78	800	125	0.67	60	40	2.2	—	—	—	S series
		D360SC4M	40	360	64	1600	125	0.6	120	80	4.2	—	—	—	S series
		D360SC6M	60	360	58	1600	125	0.67	120	80	4.4	—	—	—	S series











FAST RECOVERY DIODES

Fast Recovery Diodes are high speed type PN junction rectifying devices.

These diodes for the switching of power supply are suitable for use in household appliances, OA apparatuses, and FA apparatuses.

Series	Feature
K	Low Vf
ML	Low Vf, Low trr, Soft Recovery
US	Ultra Fast, Soft Recovery
A	Ultra Fast, Low Vf

Single

Surface Mount											
Package	JEDEC Code JEITA Code House Name	Fig.	IF(AV) [A]	VRRM[V]						Remarks	
				200	400	600	700	1000	1200		
	DO-219AA similar M1F	B2	1			M1FK60					
			1.1	M1FL20U							
			1.5		M1FL40U						
	DO-214AC 1F	B3-1	0.8			D1FK60	D1FK70				① ← → ②
			1					D1FK100	■ D1FK120P D1FK120		
	1.1		D1FL20U								
	1.5			D1FL40U							
	2				■ D2CF60K						
	SC-110B CE	B5-1	3	D3CE20LUS		D3CE60K					
	DO-214AA similar M2F	B6	1.5	M2FL20U							
			3	M3FL20U							
	-	B9-1	1.5	D2FL20U		D2FK60					
			2		■ D2FL40U						
			2.1			D3FK60					
			2.2					■ D3FK120			
	SC-63 E-pack	G1-5	3	DE3L20UA							①④ ② N.C. ③
			5			DE5L60U DE5L60A					
	TO-277A similar FY	G4	5			D5FY60K					① ②③
	SC-83 similar STO-220	H1-2	8			DF8L60US					①②④ ③
			10			DF10L60					
			20			DF20L60 DF20L60U					
	TO-252AA similar FR	G5	10			D10FR60LA					① ② N.C. ③④
			15			D15FR60LA					
	SC-83 similar FD	H2-1	8			D8FD60LUS					① ② N.C. ③④
			20			D20FD60LU					
			30			D30FD60K					

■ : New product

Single



Surface Mount																
JEDEC Code JEITA Code House Name	Fig.	Type No.	Absolute Maximum Ratings					Electrical Characteristics					Halogen free	Based on AEC-Q101	Automotive	Series
			VRRM [V]	IF(AV) [A]	Conditions Tc [°C]	IFSM [A]	Tj [°C]	Vf (max) [V]	Conditions IF [A]	Ir (max) Vr=VRRM [μA]	trr (max) [ns]					
DO-219AA similar M1F	B2	M1FK60	600	1	116 *1	15	150	1.5	1	10	75	-	○	○	K series	
		M1FL20U	200	1.1	25 *2	30	150	0.98	1.1	10	35	-	○	○	-	
		M1FL40U	400	1.5	139	30	175	1.2	1	10	25	-	■	○	-	
DO-214AC 1F	B3-1	D1FK60	600	0.8	29 *2	20	150	1.3	0.8	10	75	-	○	○	K series	
		D1FK70	700	0.8	32 *2	25	150	1.3	0.8	10	400	-	○	○	-	
		D1FK100	1000	1	97 *1	20	150	2.1	1	10	75	-	○	○	K series	
		■ D1FK120P	1200	1	79 *1	18	-55 to 150	3.0	1	10	85	-	○	■	K series	
		D1FK120	1200	1	75 *1	20	150	3.0	1	10	120	-	-	■	K series	
		D1FL20U	200	1.1	25 *2	20	150	0.98	1.1	10	35	-	○	○	-	
DO-214AC CF		■ D2CF60K	600	2	90 *1	35	-55 to 150	1.57	2	10	75	-	○	○	K series	
SC-110B CE	B5-1	D3CE20LUS	200	3	105 *1	60	-55 to 150	0.98	3	10	25	-	○	○	-	
		D3CE60K	600	3	78 *1	50	150	1.45	3	10	80	-	○	○	K series	
DO-214AA similar M2F	B6	M2FL20U	200	1.5	31 *2	50	150	0.92	1.5	10	35	-	-	○	-	
		M3FL20U	200	3	75 *1	75	150	0.95	3	10	35	-	○	○	-	
-	B9-1	D2FL20U	200	1.5	25 *2	50	150	0.98	1.5	10	35	-	○	○	-	
		D2FK60	600	1.5	101 *1	40	150	1.3	1.5	10	75	-	-	○	K series	
		■ D2FL40U	400	2	100 *1	95	-55 to 150	1.25	2	10	35	-	-	-		
		D3FK60	600	2.1	93 *1	120	150	1.2	2.1	10	75	-	-	○	K series	
-	2F	■ D3FK120	1200	2.2	91 *1	160	-55 to 150	2.1	3	10	80	-	-	-	K series	
SC-63 E-pack	G1-5	DE3L20UA	200	3	137	60	150	0.98	3	10	35	-	-	■	-	
		DE5L60U	600	5	91	60	150	3.0	5	25	25	-	-	■	-	
		DE5L60A	600	5	119	60	150	2.0	5	10	50	-	-	■	-	
TO-277A similar FY	G4	D5FY60K	600	5	130 *1	200	-55 to 150	1.25	5	10	95	○	-	■	K series	
SC-83 similar STO-220	H1-2	DF8L60US	600	8	66	60	150	3.6	8	50	25	-	-	-	US series	
		DF10L60	600	10	105	100	150	1.9	10	10	50	-	-	-	-	
		DF20L60	600	20	84	170	150	1.9	20	25	70	-	-	-	-	
		DF20L60U	600	20	93	160	150	3.0	20	25	35	-	-	-	-	
TO-252AA similar FR	G5	D10FR60LA	600	10	110	140	-55 to 150	2.1	10	10	28	-	○	■	A series	
		D15FR60LA	600	15	95	220	-55 to 150	2.1	15	10	30	-	○	■	A series	
SC-83 similar FD	H2-1	D8FD60LUS	600	8	120	60	175	3.6	8	50	25	-	-	○	US series	
		D20FD60LU	600	20	93	160	150	3.0	20	25	35	-	○	○	-	
		D30FD60K	600	30	102	300	150	1.7	30	10	95	-	-	■	K series	





■ : New product *1 : Tl *2 : Ta ■ : Please contact us.

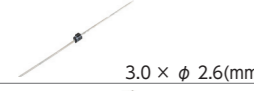

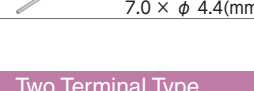
FAST RECOVERY DIODES

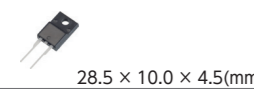
FAST RECOVERY DIODES

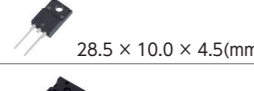
Single

Package	JEDEC Code JEITA Code House Name	Fig.	IF(AV) [A]	VRRM[V]					Remarks
				200	400	600	700	1000	
 3.0 x phi 2.6(mm)	— — AX057	A1	0.8			D1NF60 D1NK60			① ← → ②
			1	D1NL20U	D1NL40U			D1NK100	
 5.0 x phi 4.0(mm)	— — AX078	A4-1	1.5	D2L20U					① ← → ②
			2		D2L40U				
 7.0 x phi 4.4(mm)	— — AX10	A5-1	1.5	S2L20U		S2L60			① ← → ②
			2		S2L40U		S2K100		
 7.0 x phi 4.4(mm)	— — AX14	A7	2.2			S3L60			① ← → ②
			3	S3L20U	S3L40U	S3K60			

Package	JEDEC Code JEITA Code House Name	Fig.	IF(AV) [A]	VRRM[V]			Remarks
				200	400	600	
 28.5 x 10.0 x 4.5(mm)	— — SC-91A FTO-220	J1	3			SF3L60U	① ② ③
			5			SF5L60U	
			10			SF10L60U	
			20			SF20L60U	
 28.5 x 10.0 x 4.5(mm)	— — SC-91 FTO-220AG	J3	3			SF3K60M	① ②
			5		SF5L40UM	SF5K60M	
			8			SF8K60USM SF8K60M	
			10			SF10K60M SF10L60MVM SF10L60MSM SF10L60AM	
 28.5 x 10.0 x 4.5(mm)	— — SC-91 FTO-220G	J4	5	SG5L20USM			① ② ④ ③
			10	SG10L20USM			
 41.0 x 16.0 x 5.0(mm)	— — TO-247AD — MTO-3PT	K2	20			S20K60T	① ② ④ ③
			30			S30K60T	

Package	JEDEC Code JEITA Code House Name	Fig.	IF(AV) [A]	VRRM[V]			Remarks
				600	1000	1200	
 41.0 x 16.0 x 5.0(mm)	— — TO-247AD — MTO-3PV	K6	20		S20K100V		① ② ④ ③
			30	S30K60V	S30K100V		
 41.0 x 16.0 x 5.0(mm)	—	K7-2	60			 S60L120V	① ② ④ ③

 : New product

Single

Package		Type No.	Absolute Maximum Ratings				Electrical Characteristics				Halogen free	Based on AEC-Q101	Automotive	Series	
JEDEC Code JEITA Code House Name	Fig.		VRRM [V]	IF (AV) [A]	Conditions Ta [°C]	IFSM [A]	Tj [°C]	Vf (max) [V]	Conditions IF [A]	Ir (max) Vr=VRRM [μA]					ttr (max) [ns]
— — AX057	A1	D1NF60	600	0.8	25	50	150	1.3	0.8	10	400	—	—	—	—
		D1NK60	600	0.8	26	35	150	1.3	0.8	10	75	—	—	—	K series
		D1NL20U	200	1	25	25	150	0.98	1	10	35	—	—	—	—
		D1NL40U	400	1	137 *1	50	150	1.25	1	10	25	—	—	—	—
— — AX078	A4-1	D2L20U	200	1.5	125 *1	40	150	0.98	1.5	10	35	—	—	—	—
		D2L40U	400	2	108 *1	80	150	1.25	2	10	35	—	—	—	—
— — AX10	A5-1	S2L20U	200	1.5	25	50	150	0.98	1.5	10	35	—	—	—	—
		S2L60	600	1.5	125 *1	50	150	1.5	1.5	10	50	—	—	—	—
		S2L40U	400	2	120 *1	100	150	1.25	2	10	35	—	—	—	—
— — AX14	A7	S2K100	1000	2	91 *1	65	150	2.1	2	10	75	—	—	—	K series
		S3L60	600	2.2	132 *1	60	150	1.5	2.2	10	50	—	—	—	—
		S3L20U	200	3	128 *1	60	150	0.98	2.1	10	35	—	—	—	—
		S3L40U	400	3	126 *1	150	150	1.25	3	10	35	—	—	—	—
		S3K60	600	3	123 *1	120	150	1.3	3	10	100	—	—	—	K series

*1 : TI

Package		Type No.	Absolute Maximum Ratings				Electrical Characteristics				Halogen free	Based on AEC-Q101	Automotive	Series	
JEDEC Code JEITA Code House Name	Fig.		VRRM [V]	IF (AV) [A]	Conditions Tc [°C]	IFSM [A]	Tj [°C]	Vf (max) [V]	Conditions IF [A]	Ir (max) Vr=VRRM [μA]					ttr (max) [ns]
— — SC-91A FTO-220	J1	SF3L60U	600	3	115	40	150	3.00	3	25	20	—	—	—	—
		SF5L60U	600	5	96	60	150	3.00	5	25	25	—	—	—	—
		SF10L60U	600	10	85	120	150	3.00	10	25	25	—	—	■	—
		SF20L60U	600	20	68	180	150	3.00	20	25	35	—	—	■	—
— — SC-91 FTO-220AG	J3	SF3K60M	600	3	132	90	150	1.45	3	10	80	—	—	—	K series
		SF5L40UM	400	5	121	100	150	1.25	5	10	30	—	—	■	—
		SF5K60M	600	5	119	120	150	1.50	5	10	85	—	—	■	K series
		SF8K60USM	600	8	70	60	150	3.60	8	50	25	—	—	—	US series
		SF8K60M	600	8	108	150	150	1.50	8	10	90	—	—	■	K series
		SF10K60M	600	10	106	180	150	1.50	10	10	95	—	—	—	K series
		SF10L60MVM	600	10	119	200	150	1.10	10	10	115	—	—	■	ML series
		SF10L60MSM	600	10	110	160	150	1.37	10	10	60	—	—	■	ML series
		SF10L60AM	600	10	106	180	-55 to 150	2.10	10	10	28	—	—	—	A series
		SF20K60M	600	20	96	240	150	1.50	20	10	95	—	—	—	K series
		SF20L60MVM	600	20	106	250	150	1.10	20	10	130	—	—	■	ML series
		SF20L60MSM	600	20	96	220	150	1.37	20	10	70	—	—	■	ML series
SF20L60AM	600	20	77	260	-55 to 150	2.10	20	10	35	—	—	—	A series		
— — SC-91 FTO-220G	J4	SG5L20USM	200	5	125	90	150	0.96	5	10	25	—	—	—	—
		SG10L20USM	200	10	101	200	150	0.96	10	10	25	—	—	—	—
— — TO-247AD — MTO-3PT	K2	S20K60T	600	20	121	300	150	1.50	20	10	95	—	—	—	K series
		S30K60T	600	30	123	450	150	1.50	30	10	100	—	—	—	K series



■ : Please contact us.





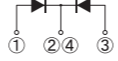

Package		Type No.	Absolute Maximum Ratings				Electrical Characteristics				Halogen free	Based on AEC-Q101	Automotive	Series	
JEDEC Code JEITA Code House Name	Fig.		VRRM [V]	IF (AV) [A]	Conditions Tc [°C]	IFSM [A]	Tj [°C]	Vf (max) [V]	Conditions IF [A]	Ir (max) Vr=VRRM [μA]					ttr (max) [ns]
— — TO-247AD — MTO-3PV	K6	S20K100V	1000	20	127	550	150	2.10	20	10	120	—	—	○	K series
		S30K60V	600	30	108	450	150	1.50	30	10	100	—	—	○	K series
		S30K100V	1000	30	116	600	150	2.10	30	10	120	—	—	○	K series
	K7-2	 S60L120V	1200	60	63	450	-55 to 150	2.7	60	100	300	—	—	—	—

 : New product

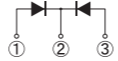
FAST RECOVERY DIODES

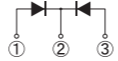
Center Tap, Common Cathode

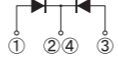
Surface Mount								
Package	JEDEC Code JEITA Code House Name	Fig.	I _{F(AV)} [A]	V _{RRM} [V]				Remarks
				200	300	400	600	
 9.5 × 6.6 × 2.65(mm)	SC-63 E-pack	G1-1	5	DE5LC20U				
 13.2 × 10.2 × 4.7(mm)	SC-83 similar STO-220	H1-1	10	DF10LC20U	DF10LC30			
			20	DF20LC20US	DF20LC30			
 13.2 × 10.2 × 4.6(mm)	SC-83 similar FD	H2-2	20	D20FDC20L D20FDC20LUS				

Three Terminal Type								
Package	JEDEC Code JEITA Code House Name	Fig.	I _{F(AV)} [A]	V _{RRM} [V]				Remarks
				200	300	400	600	
 28.5 × 10.0 × 4.5(mm)	SC-91 FTO-220AG	J8-1	5			SF5LC40UM		
			10			SF10LC40UM	SF10KC60M	
			20		SF20LC30M		SF20KC60M	
 28.5 × 10.0 × 4.5(mm)	SC-91 FTO-220G	J9	5	SG5LC20USM				
			10	SG10LC20USM				
			20	SG20LC20USM				
 41.0 × 16.0 × 5.0(mm)	TO-247AD MTO-3PT	K5-2	20	S20LC20UST	S20LC30T	S20LC40UT	S20LC60UST	
 41.0 × 16.0 × 5.0(mm)	TO-247AD MTO-3PV	K7-1	20			S20LC40UV	S20LC60USV	

Center Tap, Common Cathode

Surface Mount															
Package		Type No.	Absolute Maximum Ratings					Electrical Characteristics				Halogen free	Based on AEC-Q101	Automotive	Series
JEDEC Code JEITA Code House Name	Fig.		V _{RRM} [V]	I _{F(AV)} [A]	Conditions T _C [°C]	I _{FSM} [A]	T _J [°C]	V _F (max) [V]	Conditions I _F [A]	I _R (max) V _R =V _{RRM} [μA]	t _{rr} (max) [ns]				
SC-63 E-pack	G1-1	DE5LC20U	200	5	81	50	150	0.98	2.5	10	35	—	—	■	—
SC-83 similar STO-220	H1-1	DF10LC20U	200	10	127	80	150	0.98	5	10	35	—	—	—	—
		DF10LC30	300	10	124	80	150	1.30	5	25	30	—	—	—	—
		DF20LC20US	200	20	125	180	150	0.96	10	10	25	—	—	—	—
		DF20LC30	300	20	124	180	150	1.30	10	25	30	—	—	—	—
SC-83 similar FD	H2-2	D20FDC20L	200	20	113	100	175	1.20	10	10	30	—	○	○	—
		D20FDC20LUS	200	20	125	180	150	0.96	10	10	25	—	—	○	—

■ : Please contact us.







Three Terminal Type															
Package		Type No.	Absolute Maximum Ratings					Electrical Characteristics				Halogen free	Based on AEC-Q101	Automotive	Series
JEDEC Code JEITA Code House Name	Fig.		V _{RRM} [V]	I _{F(AV)} [A]	Conditions T _C [°C]	I _{FSM} [A]	T _J [°C]	V _F (max) [V]	Conditions I _F [A]	I _R (max) V _R =V _{RRM} [μA]	t _{rr} (max) [ns]				
SC-91 FTO-220AG	J8-1	SF5LC40UM	400	5	132	80	150	1.25	2.5	10	30	—	—	—	—
		SF10LC40UM	400	10	120	100	150	1.25	5	10	30	—	—	—	—
		SF10KC60M	600	10	109	120	150	1.50	5	10	85	—	—	■	K series
		SF20LC30M	300	20	107	250	150	1.30	10	25	30	—	—	—	—
		SF20KC60M	600	20	97	180	150	1.50	10	10	95	—	—	■	K series
SC-91 FTO-220G	J9	SG5LC20USM	200	5	133	70	150	0.96	2.5	10	25	—	—	—	—
		SG10LC20USM	200	10	122	90	150	0.96	5	10	25	—	—	—	—
		SG20LC20USM	200	20	95	150	150	0.96	10	10	25	—	—	—	—
TO-247AD MTO-3PT	K5-2	S20LC20UST	200	20	126	120	150	0.96	10	10	25	—	—	—	—
		S20LC30T	300	20	124	220	150	1.30	10	25	30	—	—	—	—
		S20LC40UT	400	20	123	130	150	1.25	10	10	30	—	—	—	—
		S20LC60UST	600	20	63	60	150	3.60	10	50	25	—	—	—	—
TO-247AD MTO-3PV	K7-1	S20LC40UV	400	20	123	200	150	1.25	10	10	30	—	—	○	—
		S20LC60USV	600	20	65	60	150	3.60	10	50	25	—	—	○	—

■ : Please contact us.

THYRISTORS



The Thyristor, in its normal state, will block an applied voltage in either direction, but when an appropriate current pulse is applied to the gate, current will flow through the anode to the cathode thus turning on power to the load circuit.
 The Thyristor has a planar passivation, and is available in both the general reverse-blocking type and the type without reverse voltage.
 The Thyristor without reverse voltage is suitable for a circuit limiting inrush current.

Thyristors

Package	 10.0 × 6.6 × 2.3(mm)	 28.5 × 10.0 × 4.5(mm)		
JEDEC Code JEITA Code House Name	TO-252AA — FB	— SC-91 FTO-220AG		
Fig.	G2-2	J8-5		
Internal Circuit				
$I_T(AV)$ [A]	3	5	5	8
V_{DRM} [V]	400	KC3FB40H	KC5FB40H	
	600		KC5FB60H KC5FB60HR KC5FB60HRT	 KC5SF60HRT
	800			 KC8SF80

 : New product

Thyristors

Package		Type No.	Absolute Maximum Ratings						Electrical Characteristics					Halogen free	Based on AEC-Q101	Automotive
JEDEC Code JEITA Code House Name	Fig.		V_{DRM} [V]	V_{RRM} [V]	$I_T(AV)$ [A]	Conditions T_c [°C]	I_{TSM} [A]	T_j [°C]	$V_{TM(max)}$ [V]	Conditions I_{TM} [A]	$V_{GT(max)}$ [V]	$I_{GT(max)}$ [μA]	$I_H(max)$ [mA]			
TO-252AA — FB	G2-2	KC3FB40H	400	400	3	111	40	-40 to 125	1.4	4	0.8	100	5	—	—	—
		KC5FB40H	400	400	5	101	65	-40 to 125	1.6	10	0.8	200	typ.1	—	—	—
		KC5FB60H	600	600	5	98	90	-40 to 125	1.8	15	0.8	100	5	—	—	—
		KC5FB60HR	600	—	5	98	90	-40 to 125	1.8	15	0.8	100	5	—	—	—
— SC-91 FTO-220AG	J8-5	 KC5SF60HRT	600	—	5	127	82	-40 to 150	1.8	15	0.8	100	5	—	—	—
		 KC8SF80	800	800	8	130	120	-40 to 150	1.5	20	1.0	15mA	100	—	—	—



 : New product

SIDACs

SIDAC series are two-terminal bidirectional thyristor energized by the addition of a specific voltage. They are commonly used for switching devices or pulse generating devices.



Bi-directional (K1V series)

- Features**
 - Symmetrical characteristics.
 - Operating directly from the AC mains, and can be used in all kinds of pulse generating circuits.
 - The glass passivation ensures high reliability.
- Applications**
 - Pulse generation : gas igniters, HID (high intensity discharge) lamp drive circuit, etc.
 - AC switching : drive circuit for switching power supplies, voltage detecting circuits, etc.
 - Over voltage protection : AC line surge protection, capacitor rupture prevention, etc.

Package			
JEDEC Code	DO-214AC	-	-
JEITA Code	-	-	-
House Name	1F	AX06	AX10
Fig.	B4-3	A2-1	A5-3, AX10, A6
Internal Circuit	①—N—②		
V _{DRM} [V]	5	K1VZL09	
	15	K1VZL20	
	90		K1V(A)10, K1V(A)11, K1V(A)12, K1V(A)16
	115		K1V10, K1V11, K1V12, K1V14
	180		K1V22, K1V24, K1V26
	270		K1V22(W), K1V24(W), K1V26(W), K1V36(W), K1V38(W)

Uni-directional (G1V series)

- Features**
 - Uni-directional characteristics.
 - Smaller package than bi-directional SIDAC.
 - Switching operation from DC power for pulse generation.
 - The glass passivation ensures high reliability.
- Applications**
 - Pulse generation : gas igniters, negative ion generators, HID (high intensity discharge) lamp drive circuit, etc.
 - Over voltage protection : DC line surge protection.

Package			
JEDEC Code	DO-214AC	-	-
JEITA Code	-	-	-
House Name	1F	AX06	AX078
Fig.	B3-3	A2-3	A4-3
Internal Circuit	①—M—②		
V _{DRM(A)} [V]	70	G1VL8C	G1V(A)8C
	90	G1VL10C	G1V(A)10C
	100		G1V(A)12C
	110		G1V(A)13C
	115		G1V(A)15C
	120	G1VL15C	G1V(A)14C
	170	G1VL20C	G1V(A)20C
	190, 210	G1VL22C, G1VL24C	

Bi-directional (K1V series)

Surface Mount		Type No.	Absolute Maximum Ratings					Electrical Characteristics					Halogen free	Automotive		
JEDEC Code	Fig.		V _{DRM}	I _T	Conditions	T _{stg}	T _j	V _{BO}	I _{DRM}	Conditions	I _{BO}	I _H			V _T	Conditions
JEITA Code	House Name	[V]	[A]	T _L [°C]	[°C]	[°C]	[V]	[μA]	V _D [V]	[mA]	[mA]	[V]	I _T [A]			
DO-214AC	B4-3	K1VZL09	5	0.5	110	-40 to 125	125	8 to 12	5	5	20	20	1.2	0.5	-	-
-	1F	K1VZL20	15	0.5	110	-40 to 125	125	18 to 22	5	15	20	20	1.2	0.5	-	-

Axial		Type No.	Absolute Maximum Ratings							Electrical Characteristics					Halogen free	Automotive
JEDEC Code	Fig.		V _{DRM}	I _T	Conditions	I _{TRM}	I _{TRM}	Conditions	diT/dt	T _j	V _{BO}	I _H	V _T	Conditions		
JEITA Code	House Name	[V]	[A]	T _L [°C]	[A]	[A]	f [Hz]	[A/μs]	[°C]	[V]	[mA]	[V]	I _T [A]			
-	AX06	K1V(A)10	90	1	109	16	60	60	125	95 to 113	50	1.6	1	-	-	
-	-	K1V(A)11	90	1	109	16	60	60	125	104 to 118	50	1.6	1	-	-	
-	-	K1V(A)12	90	1	109	16	60	60	125	110 to 125	50	1.6	1	-	-	
-	-	K1V(A)16	115	1	98	16	60	60	125	145 to 170	50	1.6	1	-	-	
-	AX10	K1V10	90	1	112	20	80	60	125	95 to 113	50	1.5	1	-	-	
-	-	K1V11	90	1	112	20	80	60	125	104 to 118	50	1.5	1	-	-	
-	-	K1V12	90	1	112	20	80	60	125	110 to 125	50	1.5	1	-	-	
-	-	K1V14	115	1	109	20	80	60	125	125 to 150	30	1.5	1	-	-	
-	-	K1V22	180	1	108	20	50	60	125	200 to 230	20	1.5	1	-	-	
-	-	K1V24	180	1	108	20	50	60	125	220 to 250	20	1.5	1	-	-	
-	-	K1V26	180	1	108	20	50	60	125	240 to 270	20	1.5	1	-	-	
-	-	K1V22(W)	180	1	91	16	50	60	125	200 to 230	50	3	1	-	-	
-	-	K1V24(W)	180	1	91	16	50	60	125	220 to 250	50	3	1	-	-	
-	-	K1V26(W)	180	1	91	16	50	60	125	240 to 265	50	3	1	-	-	
-	-	K1V36(W)	270	1	92	13	40	60	125	340 to 380	50	3	1	-	-	
-	-	K1V38(W)	270	1	92	13	40	60	125	360 to 400	50	3	1	-	-	

Uni-directional (G1V series)

Surface Mount		Type No.	Absolute Maximum Ratings					Electrical Characteristics					Halogen free	Automotive	
JEDEC Code	Fig.		V _{DRM(A)}	I _T	Conditions	I _{TRM}	Conditions	diT/dt	T _j	V _{BO(A)}	I _{H(A),(K)}	V _{T(A),(K)}			Conditions
JEITA Code	House Name	[V]	[A]	T _L [°C]	[A]	f [Hz]	[A/μs]	[°C]	[V]	[mA]	[V]	I _T [A]			
DO-214AC	B3-3	G1VL8C	70	1	98	80	60	150	125	75 to 90	100	1.5	1	-	-
-	-	G1VL10C	90	1	98	150	60	150	125	95 to 110	100	1.5	1	-	-
-	-	G1VL15C	120	1	98	120	60	150	125	142 to 157	60	1.5	1	-	-
-	-	G1VL20C	170	1	98	120	60	150	125	190 to 210	60	1.5	1	-	-
-	-	G1VL22C	190	1	98	280	5	150	125	210 to 230	60	1.5	1	-	-
-	-	G1VL24C	190	1	98	280	5	150	150	230 to 250	60	1.5	1	-	-

Axial		Type No.	Absolute Maximum Ratings					Electrical Characteristics					Halogen free	Automotive	
JEDEC Code	Fig.		V _{DRM(A)}	I _T	Conditions	I _{TRM}	Conditions	diT/dt	T _j	V _{BO(A)}	I _{H(A),(K)}	V _{T(A),(K)}			Conditions
JEITA Code	House Name	[V]	[A]	T _L [°C]	[A]	f [Hz]	[A/μs]	[°C]	[V]	[mA]	[V]	I _T [A]			
-	AX06	G1V(A)8C	70	1	98	80	60	80	125	75 to 90	100	1.5	1	-	-
-	-	G1V(A)10C	90	1	98	80	60	80	125	95 to 110	60	1.5	1	-	-
-	-	G1V(A)12C	100	1	98	80	60	80	125	110 to 130	60	1.5	1	-	-
-	-	G1V(A)13C	110	1	98	80	60	80	125	120 to 138	60	1.5	1	-	-
-	-	G1V(A)14C	120	1	98	80	60	80	125	130 to 150	60	1.5	1	-	-
-	-	G1V(A)15C	115	1	98	80	60	80	125	142 to 157	60	1.5	1	-	-
-	-	G1V(A)20C	170	1	98	80	60	80	125	190 to 210	60	1.5	1	-	-
-	AX078	G1V(B)20C	170	1	102	120	60	220	150	190 to 210	60	1.5	1	-	-
-	-	G1V(B)22C	190	1	98	160	60	220	125	210 to 230	60	1.5	1	-	-
-	-	G1V(B)24C	210	1	102	120	60	220	150	230 to 250	60	1.5	1	-	-



TRIACs

TRIACs are bidirectional Thyristors.

Our TRIACs are easy to use for motor and heater controls due to balanced gate sensitivity and (di/dt)_c.

Our lineup ranges from V_{DRM}=600 or 800V, I_{T(RMS)}=3 to 20A.

TRIACs (Triode for Alternating Current)

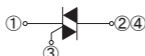
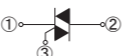
Package	 10.0 × 6.6 × 2.3(mm)	 28.5 × 10.0 × 4.5(mm)		
JEDEC Code JEITA Code House Name	TO-252AA — FB	— SC-91 FTO-220AG		
Fig.	G2-3	J8-4		
Internal Circuit				
V _{DRM} [V]	600			
	800			
I _{T(RMS)} [A]	3	KD3FB60	KD3SF60E KD3SF60	
	5		KD5SF60 ★ KD5SF80	
	8		Ⓝ KD5SF60S KD8SF60 Ⓝ KD8SF60S	Ⓝ KD8SF80
	12		KD12SF60 Ⓝ KD12SF60S	Ⓝ KD12SF80
	16		KD16SF60 Ⓝ KD16SF60S	★ KD16SF80
	20		KD20SF60 Ⓝ KD20SF60S	★ KD20SF80

Ⓝ : New product ★ : Under development

TRIACs (Triode for Alternating Current)

Surface Mount		Type No.	Absolute Maximum Ratings			Electrical Characteristics						Halogen free	Based on AEC-Q101	Automotive
JEDEC Code JEITA Code House Name	Fig.		V _{DRM} [V]	I _T (RMS) [A]	T _J [°C]	V _{TM} (max) [V]	Conditions I _{TM} [A]	V _{GT} (max) (I, II, III)* [V]	I _{GT} (max) (I, II, III)* [mA]	(dv/dt) _c (min) (T _j =150°C, V _D =2/3V _{DRM}) [V/μs]	Conditions (di/dt) _c [A/ms]			
TO-252AA — FB	G2-3	KD3FB60	600	3	-40 to 150	1.7	4.5	1.5	15	1	-1.5	—	—	—

* : Operation mode IV is not guaranteed.

Three Terminal Type		Type No.	Absolute Maximum Ratings			Electrical Characteristics						Halogen free	Based on AEC-Q101	Automotive
JEDEC Code JEITA Code House Name	Fig.		V _{DRM} [V]	I _T (RMS) [A]	T _J [°C]	V _{TM} (max) [V]	Conditions I _{TM} [A]	V _{GT} (max) (I, II, III)* [V]	I _{GT} (max) (I, II, III)* [mA]	(dv/dt) _c (min) (T _j =150°C, V _D =2/3V _{DRM}) [V/μs]	Conditions (di/dt) _c [A/ms]			
— SC-91 FTO-220AG	J8-4	KD3SF60E	600	3	-40 to 150	1.5	4.5	1.5	10	—	—	—	—	—
		KD3SF60	600	3	-40 to 150	1.5	4.5	1.5	20	1	-1.5	—	—	—
		KD5SF60	600	5	-40 to 150	1.8	7	1.5	20	1	-2.5	—	—	—
		KD8SF60	600	8	-40 to 150	1.6	12	1.5	30	1	-4.0	—	—	—
		KD12SF60	600	12	-40 to 150	1.6	20	1.5	30	1	-6.0	—	—	—
		KD16SF60	600	16	-40 to 150	1.5	25	1.5	30	1	-8.0	—	—	—
		KD20SF60	600	20	-40 to 150	1.4	30	1.5	30	1	-10.0	—	—	—
		Ⓝ KD5SF60S	600	5	-40 to 150	1.5	4.5	1.5	20	1	-1.5	—	—	—
		Ⓝ KD8SF60S	600	8	-40 to 150	1.8	7	1.5	20	1	-2.5	—	—	—
		Ⓝ KD12SF60S	600	12	-40 to 150	1.6	12	1.5	30	1	-4	—	—	—
		Ⓝ KD16SF60S	600	16	-40 to 150	1.6	20	1.5	30	1	-6	—	—	—
		Ⓝ KD20SF60S	600	20	-40 to 150	1.5	25	1.5	30	1	-8	—	—	—
		★ KD5SF80	800	5	-40 to 150	1.8	7	1.5	35	1	-1.5	—	—	—
		Ⓝ KD8SF80	800	8	-40 to 150	1.6	12	1.5	35	1	-4	—	—	—
		Ⓝ KD12SF80	800	12	-40 to 150	1.6	20	1.5	35	1	-4	—	—	—
★ KD16SF80	800	16	-40 to 150	1.5	25	1.5	35	1	-4	—	—	—		
Ⓝ KD20SF80	800	20	-40 to 150	1.4	30	1.5	35	1	-4	—	—	—		

Ⓝ : New product ★ : Under development * : Operation mode IV is not guaranteed.

Operation Mode	Terminal Characteristics		
	① T1	②④ T2	③ G
I	—	+	+
II	—	+	—
III	+	—	—
IV	+	—	+



SURGE ABSORBERS

Surge Absorbers are semiconductor devices of the Thyristor type that turns on when triggered by their rated voltage. They are commonly used for lightning surge protection in communications equipment.

Thyristor Surge Suppressors

- Features**
 - Bi-directional or uni-directional characteristics.
 - High speed response.
 - Large surge current capacity.
 - Repetitive use against surges is possible.

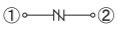
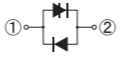

- Applications**
 - Lightning surge adsorption for communications circuits.
 - Lightning surge adsorption for transmitters and switchboards.
 - Surge protection for ISDN terminals.

Series	KL series	KU series	KP series	
Package	 5.0 × 2.5 × 2.0(mm)	 5.1 × 3.75 × 2.0(mm)	 7.6 × 4.0 × 2.8(mm)	
JEDEC Code JEITA Code House Name	DO-214AC - 1F	DO-214AA similar - M2F	- - 2F	
Fig.	B4-3	B7 B8	B9-4	
Internal Circuit				
Off-state Voltage V _D [V]	5	KL3Z07		
	15	KL3Z18		
	58	KL3L07		
	63		KU10L08	
	70		KU4F8	
	90		KU10NU11	
	92			KP20NU11 KP40NU11
	100		KU4F12	
	115		KU10NU13	
	120	KL3N14	KU10N14 KU15N14	
	175	KL3R20		
	180			KP40RU22
	190		KU10R23NS	
	220		KU10R27NS	
250		KU10R29NS		
275		KU5S31NS KU10S31NS KU10S35NS		

Varistor

- Features**
 - Bi-directional surge absorption is possible.
 - Low junction capacitance.

- Applications**
 - Telephone set surge absorption.
 - Digital communications circuit surge absorption.
 - ISDN terminal surge absorption.

Package	 5.0 × 2.5 × 2.0(mm)
JEDEC Code JEITA Code House Name	DO-214AC - 1F
Fig.	B4-1
Internal Circuit	
V _F [V]	2.3 ± 0.25
	VR61F1

Thyristor Surge Suppressors

Package		Type No.	Absolute Maximum Ratings				Electrical Characteristics			Halogen free	UL	Automotive
JEDEC Code JEITA Code House Name	Fig.		V _{BRM} [V]	I _{ISM} [A]	Conditions [μs]	T _J [°C]	V _{BO} (min) [V]	I _H (min) [mA]	C _t (max) [pF]			
DO-214AC - 1F	B4-3	KL3Z07	5	30	10/1000	125	5.5 *1	50	-	-	-	
		KL3Z18	15	30	10/1000	125	15.5 *1	50	-	-	-	
		KL3L07	58	30	10/1000	125	65	100	90	-	-	
		KL3N14	120	30	10/1000	125	130	100	50	-	-	
		KL3R20	175	30	10/1000	125	180	100	30	-	-	
DO-214AA similar - M2F	B7	KU10L08	63	100	10/1000	125	70	100	180	-	UL	-
		KU4F8	70	40	10/1000	125	75	100	100	-	-	-
	B7	KU10NU11	60	100	10/1000	125	100	150	-	-	-	-
		KU4F12	100	40	10/1000	125	110	100	100	-	-	-
		KU10NU13	60	100	10/1000	125	120	100	-	-	-	-
		KU10N14	120	100	10/1000	125	125	100	140	-	UL	-
		KU15N14	120	150	10/1000	125	125	100	110	-	UL	-
		KU10R23NS	190	100	10/1000	125	290 *2	100	90	-	-	-
		KU10R27NS	220	100	10/1000	125	320 *2	100	70	-	UL	-
		KU10R29NS	250	100	10/1000	125	400 *2	100	70	-	UL	-
B9-4	KU5S31NS	275	50	10/1000	125	420 *2	150	70	-	-	-	
	KU10S31NS	275	100	10/1000	125	420 *2	100	90	-	UL	-	
- - 2F	B9-4	KU10S35NS	275	100	10/1000	125	450 *2	100	90	-	-	-
		KP20NU11	60	325	10/700	125	100	150	295 *3	-	-	-
		KP40NU11	60	500	10/700	125	100	150	485 *3	-	-	-
		KP40RU22	60	500	10/700	125	195	100	285 *3	-	-	-

*1 : V_{BR} *2 : V_{CL(max)} *3 : typ.  : UL497B recognized (UL File No. E183905)

Varistor

Package		Type No.	Absolute Maximum Ratings			Electrical Characteristics		Halogen free	Automotive
JEDEC Code JEITA Code House Name	Fig.		I _{F(RMS)} [A]	I _{FSM(RMS)} [A]	T _J [°C]	V _F [V]	Conditions I _F [mA]		
DO-214AC - 1F	B4-1	VR61F1	0.37(*1)/0.28(*2)	7.5	-55 to 150	2.3 ± 0.25	1	-	-

*1 : On alumina substrate *2 : On glass-epoxy substrate

TVS (Transient Surge Suppressor)

TVSs are low voltage PN junction type devices. These devices utilize technologically stable glass passivation (an in-house design) with a structural advantage that brings high resistance against heat and humidity. They are available with a voltage range between 12 to 320V and peak pulse power from 200 to 8000W.

TVS

- Features
 - High speed response.
 - Absorption energy tolerance capacity.
 - Narrow clamping voltage width.
 - Lineup of Bi-directional type (DL series) for surge absorption.
- Applications
 - IC protection for telephones.
 - IC protection against abnormal voltage.
 - Protection for load dump noise.

Peak pulse power	200W		600W	2000W			6000 ~ 8000W (Load Dump Surge Protecting)				
Package											
JEDEC Code	DO-219AB similar	DO-214AC	DO-214AC	SC-110B			SC-83 similar	TO-263AB			
JEITA Code	SC-109	1F	1F	CE			STO-220	FZ			
House Name	G1F										
Fig.	B1-2	B3-2	B4-2	B5-2	B9-5	B10	B11	E1	H1-6	H6	
Internal Circuit											
12.5	ST02-12G1	ST04-12F1									
14	ST02-14G1	ST04-14F1						ST80-14MF			
16	ST02-16G1	ST04-16F1									
18	ST02-18G1	ST04-18F1	DL04-18F1	★ ST06-18CE							
20	ST02-20G1	ST04-20F1									
24	ST02-24G1	ST04-24F1									
27	ST02-27G1	ST04-27F1		★ ST06-27CE		ST20-27F2	★ DL20B-27F2	ST70-27MF	ST70-27F	★ ST70-27FZ	
30	ST02-30G1	ST04-30F1		★ ST06-30CE		ST20-30F2	★ DL20B-30F2	ST70-30MF			
33	ST02-33G1	ST04-33F1	DL04-33F1	★ ST06-33CE		ST20-33F2	★ DL20B-33F2				
36	ST02-36G1	ST04-36F1	DL04-36F1	★ ST06-36CE		ST20-36F2	★ DL20B-36F2				
39	ST02-39G1	ST04-39F1		★ ST06-39CE							
40								ST60-40MF			
43	ST02-43G1	ST03-43F1									
47	ST02-47G1	ST03-47F1			ST20-47F2						
48								ST60-48MF			
58	ST02-58G1	ST03-58F1									
68		ST03-68F1									
75		ST02-75F1									
82		ST02-82F1									
100		ST02-100F1									
120		ST02-120F1									
145		ST02-140F1									
170		ST02-170F1									
200		ST02-200F1									
240		ST03-240F1									
280		ST02-280F1									
320		ST02-320F1									

★ : New product ★ : Under development

TVS

JEDEC Code JEITA Code House Name	Fig.	Type No.	Absolute Maximum Ratings				Electrical Characteristics					Halogen free	Based on AEC-Q101	Automotive		
			PrSM [W]	V _R (DC) [V]	I _{RSM} [A]	T _J [°C]	V _{BR} (min) [V]	V _{BR} (max) [V]	Conditions I _R [mA]	I _R (max) [μA]	Conditions V _R [V]					
DO-219AB similar SC-109 G1F	B1-2	ST02-12G1	200	9	11.2	-55 to 175	11.5	13.5	5	5	9	-	○	○		
		ST02-14G1	200	12.8	10.0	-55 to 175	13.5	15	5	5	12.8	-	○	○		
		ST02-16G1	200	13.6	9.1	-55 to 175	14.4	17.6	5	5	13.6	-	○	○		
		ST02-18G1	200	13	7.5	-55 to 175	16.8	19.1	5	5	13	-	○	○		
		ST02-20G1	200	16	6.7	-55 to 175	18.8	22	5	5	16	-	○	○		
		ST02-24G1	200	20	5.8	-55 to 175	22	25.6	5	5	20	-	○	○		
		ST02-27G1	200	23	5.5	-55 to 175	25.1	28.9	2	5	23	-	○	○		
		ST02-30G1	200	24	5.0	-55 to 175	28	32	2	5	24	-	○	○		
		ST02-33G1	200	25	4.5	-55 to 175	31	35	2	5	25	-	○	○		
		ST02-36G1	200	27	4.0	-55 to 175	34	38	2	5	27	-	○	○		
		ST02-39G1	200	30	3.8	-55 to 175	37	41	2	5	30	-	○	○		
		ST02-43G1	200	33	3.5	-55 to 175	40	45	2	5	33	-	○	○		
ST02-47G1	195	37	3.0	-55 to 175	42	52	2	5	37	-	○	○				
ST02-58G1	175	45	2.2	-55 to 175	52	64	2	5	45	-	○	○				
DO-214AC 1F	B3-2	ST04-12F1	400	9	24.0	-55 to 175	11.5	13.5	1	5	9	-	○	○		
		ST04-14F1	400	12.8	18.0	-55 to 175	13.5	15	1	5	12.8	-	○	○		
		ST04-16F1	400	13.6	15.0	-55 to 175	14.4	17.6	1	5	13.6	-	○	○		
		ST04-18F1	400	15.3	15.0	-55 to 175	16.8	19.1	1	5	15.3	-	○	○		
		ST04-20F1	400	16	15.0	-55 to 175	18.8	21.2	1	5	16	-	○	○		
		ST04-24F1	400	20	12.0	-55 to 175	22.8	25.6	1	5	20	-	○	○		
		ST04-27F1	400	23	10.0	-55 to 175	24.3	29.7	1	5	23	-	○	○		
		ST04-30F1	400	24	8.5	-55 to 175	28	32	1	5	24	-	○	○		
		ST04-33F1	400	25	8.0	-55 to 175	31	35	1	5	25	-	○	○		
		ST04-36F1	400	27	7.5	-55 to 175	34	38	1	5	27	-	○	○		
		ST04-39F1	400	30	7.0	-55 to 175	37	41	1	5	30	-	○	○		
		ST03-43F1	300	33	5.0	-55 to 150	40	45	1	5	33	-	○	○		
		ST03-47F1	300	37	5.0	-55 to 150	42	52	1	5	37	-	○	○		
		ST03-58F1	300	45	4.0	-55 to 150	52	64	1	5	45	-	○	○		
		ST03-68F1	300	58	3.0	-55 to 150	64.4	71.2	1	5	58	-	○	○		
		ST02-75F1	200	61	2.0	-55 to 150	70	79	1	5	61	-	○	○		
		ST02-82F1	200	67	2.0	-55 to 150	74	90	1	5	67	-	○	○		
		ST02-100F1	200	80	1.7	-55 to 150	90	110	1	5	80	-	○	○		
		ST02-120F1	200	100	1.4	-55 to 150	110	130	1	5	33	-	○	○		
		ST02-140F1	200	120	1.0	-55 to 150	130	160	1	5	120	-	○	○		
ST02-170F1	200	145	0.75	-55 to 150	155	185	1	5	145	-	○	○				
ST02-200F1	200	170	0.7	-55 to 150	185	215	1	5	170	-	○	○				
ST03-240F1	310	200	1.0	-55 to 175	220	250	1	5	200	-	○	○				
ST02-280F1	200	230	0.5	-55 to 175	250	300	1	5	230	-	○	○				
ST02-320F1	150	260	0.38	-55 to 175	300	350	1	5	260	-	○	○				
DO-214AC 1F	B4-2	DL04-18F1	400	13	-	-55 to 150	16.8	19.1	5	5	13	-	○	○		
		DL04-33F1	400	25	9.5	-55 to 175	31	35	1	5	25	-	○	○		
		DL04-36F1	400	27	8.0	-55 to 175	34	38	1	5	27	-	○	○		
SC-110B CE	B5-2	★ ST06-18CE	600	13	26.0	-55 to 175	16.8	19.1	1	5	13	-	○	○		
		★ ST06-27CE	600	23	17.3	-55 to 175	25	29	1	5	23	-	○	○		
		★ ST06-30CE	600	24	15.0	-55 to 175	28	32	1	5	24	-	○	○		
		★ ST06-33CE	600	25	14.0	-55 to 175	31	35	1	5	25	-	○	○		
		★ ST06-36CE	600	27	12.4	-55 to 175	34	38	1	5	27	-	○	○		
		★ ST06-39CE	600	30	11.0	-55 to 175	37	41	1	5	30	-	○	○		
-	B9-5	ST20-47F2	1700	37	31.0	-55 to 175	42	52	1	5	37	-	○	○		
		ST20-27F2	2000	23	54.0	-55 to 175	24.3	29.7	1	5	23	-	○	○		
		ST20-30F2	2000	24	50.0	-55 to 175	28	32	1	5	24	-	○	○		
		ST20-33F2	2000	25	45.0	-55 to 175	31	35	1	5	25	-	○	○		
	-	B10	ST20-36F2	2000	27	40.0	-55 to 175	34	38	1	5	27	-	○	○	
			★ DL20B-27F2	2000	23	51	-55 to 175	25	29	1	5	23	-	○	○	
			★ DL20B-30F2	2000	24	46	-55 to 175	28	32	1	5	24	-	○	○	
			★ DL20B-33F2	2000	25	41	-55 to 175	31	35	1	5	25	-	○	○	
	-	B11	★ DL20B-36F2	2000	27	36	-55 to 175	34	38	1	5	27	-	○	○	
			ST80-14MF	8000	12	400	-40 to 150	13	15	1	10	12	-	-	○	
			ST70-27MF	7000	23	180	-40 to 150	24.3	29.7	1	5	23	-	-	○	
			ST70-30MF	7000	26	160	-40 to 150	27.5	33	1	5	26	-	-	○	
MCP	E1	ST60-40MF	6000	32	100	-40 to 150	36.5	44	1	5	32	-	-	○		
		ST60-48MF	6000	40	100	-40 to 150	43.2	54	1	5	40	-	-	○		
		SC-83 similar STO-220	H1-6	ST70-27F	7000	23	180	-40 to 150	24.3	29.7	1	5	23	-	-	○
		TO-263AB FZ	H6	★ ST70-27FZ	7000	23	180	-55 to 175	25	29	1	5	23	○	○	○





★ : New product ★ : Under development

TVS (Transient Surge Suppressor)

Power Clampers

- Features
 - High speed response.
 - Absorption energy tolerance capacity.
 - Narrow clamping voltage width.
 - Reverse blocking type.

- Application
 - Snubber circuit in the primary side of switch-mode power supplies.

Package	 7.6 × 4.0 × 2.8(mm)	 5.0 × φ 4.0(mm)	 7.0 × φ 4.4(mm)	
JEDEC Code	—	—	—	
JEITA Code	—	—	—	
House Name	2F	AX078	AX10	
Fig.	B9-3	A4-2	A5-2	
Internal Circuit				
V _{BR} (typ) [V]	82		ST02D-82	ST03D-82
	145	ST02D-140F2	ST02D-140	ST03D-140
	170	ST02D-170F2	ST02D-170	ST03D-170
	200		ST02D-200	ST03D-200
	240			ST03DH-240

Power Clampers

Surface Mount		Type No.	Absolute Maximum Ratings				Electrical Characteristics						Halogen free	Automotive	
Package			PrSM	ZD		Di	Tj	ZD			Di				
JEDEC Code	Fig.			VRRM	VR(DC)			VBR (min)	VBR (max)	Conditions Ir [mA]	Ir (max) [μA]	Ir (max) [μA]			Conditions VR [V]
—	B9-3	ST02D-140F2	200	120	600	-40 to 150	130	160	1	5	5	600	—	—	
2F		ST02D-170F2	200	145	600	-40 to 150	155	185	1	5	5	600	—	—	

Axial		Type No.	Absolute Maximum Ratings				Electrical Characteristics						Halogen free	Automotive	
Package			PrSM	ZD		Di	Tj	ZD			Di				
JEDEC Code	Fig.			VRRM	VR(DC)			VBR (min)	VBR (max)	Conditions Ir [mA]	Ir (max) [μA]	Ir (max) [μA]			Conditions VR [V]
— AX078	A4-2	ST02D-82	200	67	600	-40 to 150	74	90	1	5	5	600	—	—	
		ST02D-140	200	120	600	-40 to 150	130	160	1	5	5	600	—	—	
		ST02D-170	200	145	600	-40 to 150	155	185	1	5	5	600	—	—	
		ST02D-200	200	170	600	-40 to 150	185	215	1	5	5	600	—	—	
— AX10	A5-2	ST03D-82	300	67	600	-40 to 150	74	90	1	5	5	600	—	—	
		ST03D-140	300	120	600	-40 to 150	130	160	1	5	5	600	—	—	
		ST03D-170	300	145	600	-40 to 150	155	185	1	5	5	600	—	—	
		ST03D-200	300	170	600	-40 to 150	185	215	1	5	5	600	—	—	
		ST03DH-240	300	200	1000	-40 to 150	220	250	1	5	10	1000	—	—	

POWER MOSFETS

The EETMOS series offer world-class performance applying a trench-gate structure with an optimized layout hence lowered Qg.

Series	Feature
EETMOS2	Evenly balanced Ron and Qg
EETMOS3/3Z	Low Ron, Low Qg
EETMOS4	Ultra Low Ron, Low Qg

How to read

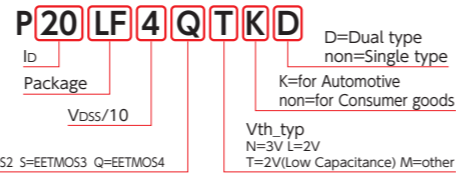

EETMOS Series (Nch Single)

Surface Mount		JEDEC Code JEITA Code House Name	Fig.	Id [A]	V _{DSS} [V]					Remarks	
Package					40	60	75	100	120		
6.0 × 4.9 × 1.0(mm)	-	LA	G6	15						P15LA12SL	
				18						P18LA12SL	
				19						P19LA10SL	
				23						P23LA10SL	
				25						P25LA12SL	
				30						P30LA10SL	
				56	P56LA4SN						
6.05 × 5.00 × 1.05(mm)	-	MO-235B similar - LF	G7	18		N P18LF6QLK N P18LF6QNK					
				24	N P24LF4QLK N P24LF4QMK N P24LF4QNK						
				25					P25LF12SLK P25LF12SL P25LF12SNK P25LF12SN		
				32					P32LF10SLK P32LF10SL P32LF10SNK P32LF10SN		
				38		N P38LF6QLK N P38LF6QL N P38LF6QNK N P38LF6QN					
				40					P40LF12SLK P40LF12SL P40LF12SNK P40LF12SN		
				46				P46LF7R5SLK P46LF7R5SL P46LF7R5SNK P46LF7R5SN			
				50				P50LF10SLK P50LF10SL P50LF10SNK P50LF10SN			
				64		N P64LF6QLK N P64LF6QL N P64LF6QNK N P64LF6QN					
				70		N P70LF4QLK N P70LF4QL N P70LF4QNK N P70LF4QN					
				72				P72LF7R5SLK P72LF7R5SL P72LF7R5SNK P72LF7R5SN			
				98		N P98LF6QLK N P98LF6QL N P98LF6QNK N P98LF6QN					
				105		N P105LF4QLK N P105LF4QL N P105LF4QNK N P105LF4QN					
				140		N P140LF4QLK N P140LF4QL N P140LF4QNK N P140LF4QN					

N : New product





EETMOS Series (Nch Single)

Surface Mount		JEDEC Code JEITA Code House Name	Fig.	Type No.	Absolute Maximum Ratings					Electrical Characteristics					Halogen free	Based on AEC-Q101	Automotive	Series
Package					V _{DSS} [V]	I _D [A]	I _{DP} [A]	P _T [W]	T _{ch} [°C]	R _{DS(on)} (typ) [mΩ] V _{GS} =10V	R _{DS(on)} (max) [mΩ] V _{GS} =10V	C _{iss} (typ) [pF]	Q _g (typ) [nC]	V _{th} (typ) [V]				
-	LA		G6	P56LA4SN	40	56	168	99	-55 to 150	4.5	5.7	1680	38	3.0	○	-	-	EETMOS3
				P19LA10SL	100	19	57	83	-55 to 150	28	35	1730	38	2.0	○	-	-	EETMOS3
				P23LA10SL	100	23	69	99	-55 to 150	23	29	2080	46	2.0	○	-	-	EETMOS3
				P30LA10SL	100	30	90	142	-55 to 150	16.8	21.0	2890	61	2.0	○	-	-	EETMOS3
				P15LA12SL	120	15	45	83	-55 to 150	40	50	1735	38.5	2.0	○	-	-	EETMOS3
				P18LA12SL	120	18	54	99	-55 to 150	35	44	2090	47	2.0	○	-	-	EETMOS3
				P25LA12SL	120	25	75	142	-55 to 150	24	30	2900	61	2.0	○	-	-	EETMOS3
				N P24LF4QLK	40	24	72	50	-55 to 175	10.6	13.2	884	21	2.0	○	○	○	EETMOS4
				N P24LF4QMK	40	24	72	50	-55 to 175	10.5	13.2	856	22	1.6	○	○	○	EETMOS4
				N P24LF4QNK	40	24	72	50	-55 to 175	11.3	14.1	756	17	3.0	○	○	○	EETMOS4
				N P70LF4QLK	40	70	210	123	-55 to 175	3.6	4.5	2360	49	2.0	○	○	○	EETMOS4
				N P70LF4QL	40	70	210	123	-55 to 175	3.6	4.5	2360	49	2.0	○	-	-	EETMOS4
				N P70LF4QNK	40	70	210	123	-55 to 175	3.9	4.9	1890	38	3.0	○	○	○	EETMOS4
				N P70LF4QN	40	70	210	123	-55 to 175	3.9	4.9	1890	38	3.0	○	-	-	EETMOS4
				N P105LF4QLK	40	105	315	168	-55 to 175	2.1	2.7	4090	76	2.0	○	○	○	EETMOS4
				N P105LF4QL	40	105	315	168	-55 to 175	2.1	2.7	4090	76	2.0	○	-	-	EETMOS4
				N P105LF4QNK	40	105	315	168	-55 to 175	2.2	2.8	3400	62	3.0	○	○	○	EETMOS4
				N P105LF4QN	40	105	315	168	-55 to 175	2.2	2.8	3400	62	3.0	○	-	-	EETMOS4
				N P140LF4QLK	40	140	560	217	-55 to 175	1.17	1.42	6630	122	2.0	○	○	○	EETMOS4
				N P140LF4QL	40	140	560	217	-55 to 175	1.17	1.42	6630	122	2.0	○	-	-	EETMOS4
N P140LF4QNK	40	140	560	217	-55 to 175	1.22	1.48	5530	96	3.0	○	○	○	EETMOS4				
N P140LF4QN	40	140	560	217	-55 to 175	1.22	1.48	5530	96	3.0	○	-	-	EETMOS4				
N P18LF6QLK	60	18	54	50	-55 to 175	22	28	920	21	2.0	○	○	○	EETMOS4				
N P18LF6QNK	60	18	54	50	-55 to 175	22	28	757	17	3.0	○	○	○	EETMOS4				
N P38LF6QLK	60	38	114	123	-55 to 175	7.9	9.9	2340	49	2.0	○	○	○	EETMOS4				
N P38LF6QL	60	38	114	123	-55 to 175	7.9	9.9	2340	49	2.0	○	-	-	EETMOS4				
N P38LF6QNK	60	38	114	123	-55 to 175	8.3	10.4	1875	35	3.0	○	○	○	EETMOS4				
N P38LF6QN	60	38	114	123	-55 to 175	8.3	10.4	1875	35	3.0	○	-	-	EETMOS4				
N P64LF6QLK	60	64	192	168	-55 to 175	4.5	5.7	4260	77	2.0	○	○	○	EETMOS4				
N P64LF6QL	60	64	192	168	-55 to 175	4.5	5.7	4260	77	2.0	○	-	-	EETMOS4				
N P64LF6QNK	60	64	192	168	-55 to 175	4.5	5.7	3540	61	3.0	○	○	○	EETMOS4				
N P64LF6QN	60	64	192	168	-55 to 175	4.5	5.7	3540	61	3.0	○	-	-	EETMOS4				
N P98LF6QLK	60	98	392	217	-55 to 175	2.5	3.2	6770	126	2.0	○	○	○	EETMOS4				
N P98LF6QL	60	98	392	217	-55 to 175	2.5	3.2	6770	126	2.0	○	-	-	EETMOS4				
N P98LF6QNK	60	98	392	217	-55 to 175	2.6	3.3	5650	96	3.0	○	○	○	EETMOS4				
N P98LF6QN	60	98	392	217	-55 to 175	2.6	3.3	5650	96	3.0	○	-	-	EETMOS4				
P46LF7R5SLK	75	46	138	168	175	8.2	10.3	2890	61	2.0	○	○	○	EETMOS3				
P46LF7R5SL	75	46	138	168	-55 to 175	8.2	10.3	2890	61	2.0	○	-	-	EETMOS3				
P46LF7R5SNK	75	46	138	168	175	8	10	2380	48	3.0	○	○	○	EETMOS3				
P46LF7R5SN	75	46	138	168	-55 to 175	8	10	2380	48	3.0	○	-	-	EETMOS3				
P72LF7R5SLK	75	72	288	217	175	4.6	5.8	4870	100	2.0	○	○	○	EETMOS3				
P72LF7R5SL	75	72	288	217	-55 to 175	4.6	5.8	4870	100	2.0	○	-	-	EETMOS3				
P72LF7R5SNK	75	72	288	217	175	4.5	5.7	4080	78	3.0	○	○	○	EETMOS3				
P72LF7R5SN	75	72	288	217	-55 to 175	4.5	5.7	4080	78	3.0	○	-	-	EETMOS3				
P32LF10SLK	100	32	96	168	175	15.7	19.7	2890	61	2.0	○	○	○	EETMOS3				
P32LF10SL	100	32	96	168	-55 to 175	15.7	19.7	2890	61	2.0	○	-	-	EETMOS3				
P32LF10SNK	100	32	96	168	175	14.4	18.0	2430	48	3.0	○	○	○	EETMOS3				
P32LF10SN	100	32	96	168	-55 to 175	14.4	18.0	2430	48	3.0	○	-	-	EETMOS3				
P50LF10SLK	100	50	200	217	175	9.0	11.3	4900	102	2.0	○	○	○	EETMOS3				
P50LF10SL	100	50	200	217	-55 to 175	9.0	11.3	4900	102	2.0	○	-	-	EETMOS3				
P50LF10SNK	100	50	200	217	175	8.3	10.4	4130	80	3.0	○	○	○	EETMOS3				
P50LF10SN	100	50	200	217	-55 to 175	8.3	10.4	4130	80	3.0	○	-	-	EETMOS3				
P25LF12SLK	120	25	75	168	175	23	29	2930	61	2.0	○	○	○	EETMOS3				
P25LF12SL	120	25	75	168	-55 to 175	23	29	2930	61	2.0	○	-	-	EETMOS3				
P25LF12SNK	120	25	75	168	175	21	27	2430	48	3.0	○	○	○	EETMOS3				
P25LF12SN	120	25	75	168	-55 to 175	21	27	2430	48	3.0	○	-	-	EETMOS3				
P40LF12SLK	120	40	160	217	175	13.0	16.3	5000	102	2.0	○	○	○	EETMOS3				
P40LF12SL	120	40	160	217	-55 to 175	13.0	16.3	5000	102	2.0	○	-	-	EETMOS3				
P40LF12SNK	120	40	160	217	175	12.3	15.4	4075	80	3.0	○	○	○	EETMOS3				
P40LF12SN	120	40	160	217	-55 to 175	12.3	15.4	4075	80	3.0	○	-	-	EETMOS3				

N : New product

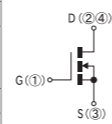
POWER MOSFETs

EETMOS Series (Nch Single)

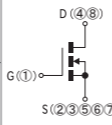
Surface Mount												
Package	JEDEC Code JEITA Code House Name	Fig.	Id [A]	Vbss [V]							Remarks	
				40	50	55	60	75	100	120		150
	TO-252AA - FB	G2-1	8								★ P8B10SBK P8B10SB	
			16								★ P16B6SBK P16B6SB	
			20								P20B12SL P20B12SN	
			24	P24B4SB								
			25								P25B6EB	
			26								★ P26B10SLK P26B10SL P26B10SN P30B10EL	
			30									
			32								★ P32B12SLK P32B12SN	
			40								P40B6SL P40B10SL P40B10SN	
			54	P54B4SN								
			60	P60B4EL P60B4SN							P60B6EL P60B6EN P60B6SN	
				TO-252AB similar SC-63 FE	G3-2	8						
12										P12FE7R5SBK		
14											P14FE6SBK	
20											P20FE12SLK	
22	P22FE4SBK											
26											P26FE10SLK	
	TO-263AB - FG	H4	30	P30FE4SLK						P30FE6SLK P30FE7R5SLK		
			32									P32FG15SL
			80									P80FG6EAL P80FG7R5EN
			85									P85FG6EAL
			90									P90FG5R5SL P94FG5R5SL
			94									
	TO-263SC - FZ-7p	H7	170							■ P170FZ6QNKA		
			240									■ P240FZ4QLA ■ P240FZ4QNKA

■ : New product ★ : Under development

THD (Through Hole Device)

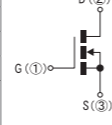
THD (Through Hole Device)												
Package	JEDEC Code JEITA Code House Name	Fig.	Id [A]	Vbss [V]							Remarks	
				40	50	60	70	75	100	120		
	- SC-91 FTO-220AG	J8-2	22								P22F10SN	
			32								P32F12SN	
			34								P34F6EL	
			40								P40F10SN P40F12SN	
			42								P42F6EN	
			50								P50F10SN	
			55								P55F6EN	
			66								P66F7R5SNK P66F7R5SN P70F7R5EN P82F7R5SN	
			70								P70F5EN	
			86								P86F6SN	

EETMOS Series (Nch Single)

Surface Mount																		
JEDEC Code JEITA Code House Name	Package	Fig.	Type No.	Absolute Maximum Ratings					Electrical Characteristics					Halogen free	Based on AEC-Q101	Automotive	Series	
				Vdss [V]	Id [A]	Idp [A]	Pt [W]	Tch [°C]	Rds(on) (typ) [mΩ] Vgs=10V	Rds(on) (max) [mΩ] Vgs=10V	Ciss (typ) [pF]	Qg (typ) [nC]	Vth (typ) [V]					
	TO-252AA - FB	G2-1	P24B4SB	40	24	72	20	-55 to 150	14.8	18.5	645	16.5	2.0	-	-	-	EETMOS3	
P54B4SN			40	54	162	44	-55 to 150	5.0	6.3	1650	36	3.0	-	-	-	-	EETMOS3	
P60B4EL			40	60	240	62.5	-55 to 150	3.3	4.2	2900	57	2.0	-	-	-	-	EETMOS2	
P60B4SN			40	60	180	62.5	-55 to 150	3.2	4.0	2830	59	3.0	-	-	-	-	EETMOS3	
★ P16B6SBK			60	16	48	23	-55 to 175	29	37	655	17	2.0	○	○	○	-	-	EETMOS3
P16B6SB			60	16	48	20	-55 to 150	29	37	655	17	2.0	-	-	-	-	-	EETMOS3
P25B6EB			60	25	70	35	-55 to 150	23	29	785	14.5	2.0	-	-	-	-	-	EETMOS2
P40B6SL			60	40	120	44	-55 to 150	9.5	12.0	2050	43	2.0	-	-	-	-	-	EETMOS3
P60B6EL			60	60	240	62.5	-55 to 150	6.1	7.7	2920	55	2.0	-	-	-	-	-	EETMOS2
P60B6EN			60	60	240	62.5	-55 to 150	6.4	8.0	2550	44	3.0	-	-	-	-	-	EETMOS2
P60B6SN			60	60	180	62.5	-55 to 150	5.3	6.7	2780	55	3.0	-	-	-	-	-	EETMOS3
★ P8B10SBK			100	8	24	23	-55 to 175	75	94	665	16.5	2.0	○	○	○	-	-	EETMOS3
P8B10SB			100	8	24	20	-55 to 150	75	94	665	16.5	2.0	-	-	-	-	-	EETMOS3
★ P26B10SLK			100	26	78	46	-55 to 175	24	30	1975	43	2.0	○	○	○	-	-	EETMOS3
P26B10SL			100	26	78	44	-55 to 150	24	30	1975	43	2.0	-	-	-	-	-	EETMOS3
P26B10SN			100	26	78	44	-55 to 150	22	28	1700	35	3.0	-	-	-	-	-	EETMOS3
P30B10EL			100	30	90	44	-55 to 150	24	30	2000	37	2.0	-	-	-	-	-	EETMOS2
P40B10SL			100	40	120	62.5	-55 to 150	14.8	18.5	3210	66	2.0	-	-	-	-	-	EETMOS3
P40B10SN			100	40	120	62.5	-55 to 150	13.4	16.8	2880	56	3.0	-	-	-	-	-	EETMOS3
P20B12SL			120	20	60	44	-55 to 150	35	44	2110	46	2.0	-	-	-	-	-	EETMOS3
P20B12SN			120	20	60	44	-55 to 150	33	42	1740	37	3.0	-	-	-	-	-	EETMOS3
★ P32B12SLK			120	32	96	75	-55 to 175	19.9	25	3513	69	2.0	○	○	○	-	-	EETMOS3
P32B12SN			120	32	96	62.5	-55 to 150	20	25	2915	57	3.0	-	-	-	-	-	EETMOS3
P22FE4SBK			40	22	66	24	-55 to 175	15.2	19.0	645	16.5	2.0	-	○	○	-	-	EETMOS3
P30FE4SLK			40	30	90	44	-55 to 175	6.3	8.0	2020	44	2.0	-	○	○	-	-	EETMOS3
P14FE6SBK			60	14	42	24	-55 to 175	31	39	655	16.3	2.0	-	○	○	-	-	EETMOS3
P30FE6SLK			60	30	90	44	-55 to 175	10.9	13.8	2050	43	2.0	-	○	○	-	-	EETMOS3
P12FE7R5SBK			75	12	36	24	-55 to 175	40	50	660	16.6	2.0	-	○	○	-	-	EETMOS3
P30FE7R5SLK			75	30	90	44	-55 to 175	14.1	17.8	2020	45	2.0	-	○	○	-	-	EETMOS3
P8FE10SBK			100	8	24	24	-55 to 175	79	99	665	16.5	2.0	-	○	○	-	-	EETMOS3
P26FE10SLK	100	26	78	44	-55 to 175	24	30	1975	43	2.0	-	○	○	-	-	EETMOS3		
P20FE12SLK	120	20	60	44	-55 to 175	35	44	2110	46	2.0	-	○	○	-	-	EETMOS3		
P90FG5R5SL	55	90	360	128	150	3.0	3.8	5130	106	2.0	-	-	-	-	-	EETMOS3		
P94FG5R5SL	55	94	376	156	150	2.5	3.2	7170	140	2.0	-	-	-	-	-	EETMOS3		
P80FG6EAL	60	80	320	128	150	3.6	4.9	4700	90	2.0	-	-	-	-	-	EETMOS2		
P85FG6EAL	60	85	340	156	150	3.2	4.3	5700	105	2.0	-	-	-	-	-	EETMOS2		
P80FG7R5EN	75	80	320	128	150	5.1	6.4	4100	67	3.0	-	-	-	-	-	EETMOS2		
P32FG15SL	150	32	96	100	150	32	40	3530	72	2.0	-	-	-	-	-	EETMOS3		
■ P240FZ4QLA	40	240	720	178	-55 to 175	1.03	1.29	9675	171	2.0	○	-	-	-	-	EETMOS4		
■ P240FZ4QNKA	40	240	720	178	-55 to 175	1.07	1.34	7915	133	3.0	○	○	○	-	-	EETMOS4		
■ P170FZ6QNKA	60	170	510	178	-55 to 175	1.93	2.4	8090	130	3.0	○	○	○	-	-	EETMOS4		

■ : New product ★ : Under development

THD (Through Hole Device)

THD (Through Hole Device)																		
JEDEC Code JEITA Code House Name	Package	Fig.	Type No.	Absolute Maximum Ratings					Electrical Characteristics					Halogen free	Based on AEC-Q101	Automotive	Series	
				Vdss [V]	Id [A]	Idp [A]	Pt [W]	Tch [°C]	Rds(on) (typ) [mΩ] Vgs=10V	Rds(on) (max) [mΩ] Vgs=10V	Ciss (typ) [pF]	Qg (typ) [nC]	Vth (typ) [V]					
	- SC-91 FTO-220AG	J8-2	P70F5EN	50	70	280	53	150	2.7	3.2	5500	100	3.0	-	-	-	EETMOS2	
P34F6EL			60	34	136	35	-55 to 150	9.0	11.0	1960	41	2.0	-	-	-	-	EETMOS2	
P42F6EN			60	42	168	40	150	6.7	8.4	2540	47	3.0	-	-	-	-	EETMOS2	
P55F6EN			60	55	220	44	150	4.4	5.5	4100	73	3.0	-	-	-	-	EETMOS2	
P86F6SN			60	86	344	58	150	2.4	3.0	9380	181	3.0	-	-	-	-	-	EETMOS3
P66F7R5SNK			75	66	264	51	-55 to 150	4.0	5.0	6070	115	3.0	-	-	-	■	-	EETMOS3
P66F7R5SN			75	66	264	51	150	4.0	5.0	6070	115	3.0	-	-	-	-	-	EETMOS3
P70F7R5EN			75	70	280	53	150	3.8	4.8	5720	105	3.0	-	-	-	-	-	EETMOS2
P82F7R5SN			75	82	328	58	-55 to 150	3.0	3.8	9600	168	3.0	-	-	-	-	-	EETMOS3
P22F10SN			100	22	66	35	150	22	28	1700	34	3.0	-	-	-	-	-	EETMOS3
P40F10SN			100	40	160	44	150	8.5	10.7	4500	92	3.0	-	-	-	-	-	EETMOS3
P50F10SN			100	50	200	51	150	6.9	8.7	5880	114	3.0	-	-	-	-	-	EETMOS3
P32F12SN			120	32	128	44	150	12.4	15.5	4540	92	3.0	-	-	-	-	-	EETMOS3
P40																		

POWER MOSFETs

EETMOS Series (Nch Dual)

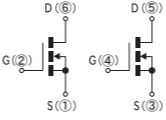
Surface Mount							
Package	JEDEC Code JEITA Code House Name	Fig.	Id [A]	Vdss [V]			Remarks
				40	60	100	
	MO-235B - LF	G8	12			<input checked="" type="checkbox"/> P12LF10SLKD	
			15		<input checked="" type="checkbox"/> P15LF6QTKD		
			17		<input checked="" type="checkbox"/> P17LF10SLKD		
			20	<input checked="" type="checkbox"/> P20LF4QTKD			
			33		<input checked="" type="checkbox"/> P33LF6QLKD <input checked="" type="checkbox"/> P33LF6QTKD		
			39		<input checked="" type="checkbox"/> P39LF6QTKD		
			41	<input checked="" type="checkbox"/> P41LF4QTKD			
			50	<input checked="" type="checkbox"/> P50LF4QTKD			

6.05 × 5.00 × 1.05(mm)

: New product

EETMOS Series (Nch Dual)

Surface Mount		Type No.	Absolute Maximum Ratings					Electrical Characteristics					Halogen free	Based on AEC-Q101	Automotive	Series	
JEDEC Code JEITA Code House Name	Package		Fig.	Vdss [V]	Id [A]	Idp [A]	Pt [W]	Tch [°C]	Rds(on) (typ) [mΩ] Vgs=10V	Rds(on) (max) [mΩ] Vgs=10V	Ciss (typ) [pF]	Qg (typ) [nC]					Vth (typ) [V]
MO-235B - LF	G8	<input checked="" type="checkbox"/> P20LF4QTKD	40	20	60	35	-55 to 175	12.3	15.3	630	16	2	○	○	○	EETMOS4	
		<input checked="" type="checkbox"/> P41LF4QTKD	40	41	123	50	-55 to 175	5.3	6.7	1478	31	2	○	○	○	EETMOS4	
		<input checked="" type="checkbox"/> P50LF4QTKD	40	50	150	62	-55 to 175	4.4	5.5	1748	35	2	○	○	○	EETMOS4	
		<input checked="" type="checkbox"/> P15LF6QTKD	60	15	45	35	-55 to 175	24	30	632	15	2	○	○	○	EETMOS4	
		<input checked="" type="checkbox"/> P33LF6QLKD	60	33	99	50	-55 to 175	10.5	13.1	1913	37	2	○	○	○	EETMOS4	
		<input checked="" type="checkbox"/> P33LF6QTKD	60	33	99	50	-55 to 175	10	12.5	1495	30	2	○	○	○	EETMOS4	
		<input checked="" type="checkbox"/> P39LF6QTKD	60	39	117	62	-55 to 175	8.3	10.4	1765	35	2	○	○	○	EETMOS4	
		<input checked="" type="checkbox"/> P12LF10SLKD	100	12	36	50	-55 to 175	34	42	1420	32	2	○	○	■	○	EETMOS3
		<input checked="" type="checkbox"/> P17LF10SLKD	100	17	51	62	-55 to 175	29	36	1685	36	2	○	○	■	○	EETMOS3

: New product : Please contact us.



POWER MOSFETS

The Hi-PotMOS series are MOSFETs with a high breakdown strength, and they are 100% screened using di/dt & avalanche testing.

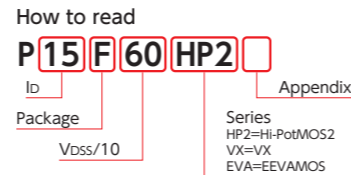



Series	Feature
HP2 (Hi-PotMOS2)	High breakdown resistance, Avalanche rated, di/dt inspection(all parts)
VX3	Automotive qualified, Avalanche rated, di/dt inspection(all parts), High Breakdown resistance, High ESD Capability
EVA (EEVAMOS)	Super junction structure, Low Ron, High Speed Switching



HP2 • VX • EVA Series (Nch Single)

Surface Mount											
Package	JEDEC Code JEITA Code House Name	Fig.	Id [A]	V _{DSS} [V]					Remarks		
				280/300	400	500/525	600	900			
	TO-252AA - FB	G2-1	0.5					P0R5B60HP2			
			1					P1B52HP2	★ P1B90VX3		
			1.5		P1R5B40HP2						
			2					P2B60HP2F	★ P2B90VX3		
			2.5					P2R5B52HP2F			
			3	P3B28HP2							
			4		P4B40HP2			P4B60HP2F			
			5					★ P5B50HP2F P5B52HP2			
			6	P6B28HP2 P8B28HP2 P8B30HP2	P6B40HP2			P6B52HP2			
			8								
10.0 × 6.6 × 2.3(mm)	TO-252AB similar SC-63 FE	G3-2	9	P9B30HP2F	P9B40HP2						
			10	P10B28HP2							
			1						P1FE90VX3		

■ : New product ★ : Under development

THD (Through Hole Device)											
Package	JEDEC Code JEITA Code House Name	Fig.	Id [A]	V _{DSS} [V]					Remarks		
				250/280	400	500	600	900			
	- SC-91 FTO-220AG	J8-2	3					P3F60HP2			
			4					P4F60HP2	■ P4F90VX3		
			5					P5F50HP2 P5F60HP2			
			6								
			7					P7F60HP2	■ P7F90VX3		
			8	P8F28HP2				P8F50HP2 P10F50HP2			
			10								
			11					★ P11F60EVA			
			12					P12F60HP2			
			13	P13F28HP2				P13F50HP2			
			15					P15F50HP2 P15F60HP2 P15F60HP2F			
			16					★ P16F60EVA			
			17	P17F28HP2							
			20					P20F50HP2			
			21	P21F28HP2					★ P21F60EVA ★ P25F60EVA		
			25								
			26	P26F28HP2							
36	■ P36F25HP2 P36F28HP2										
28.5 × 10.0 × 4.5(mm)	- SC-91 FTO-220A	J7-2	23					P23F40HP2FM			
											
41.0 × 16.0 × 5.0(mm)	TO-247AD - MTO-3PV	K7-4	30					P30W60HP2V			
	TO-247AD - GC	K8	85	■ P85GC28HP2F							
											

■ : New product ★ : Under development

HP2 • VX • EVA Series (Nch Single)

Surface Mount																
JEDEC Code JEITA Code House Name	Fig.	Type No.	Absolute Maximum Ratings				Electrical Characteristics				Body Diode trr (typ) [ns]	Halogen free	Based on AEC-Q101	Automotive	Series	
			V _{DSS} [V]	I _D [A]	P _T [W]	T _{ch} [°C]	R _{DS(ON)} (typ) [Ω] V _{GS} =10V	R _{DS(ON)} (max) [Ω] V _{GS} =10V	C _{iss} (typ) [pF]	Q _g (typ) [nC]						V _{th} (typ) [V]
TO-252AA - FB	G2-1	P3B28HP2	280	3	35	150	1.7	2.0	120	3.6	3.75	-	-	-	HP2	
		P6B28HP2	280	6	35	150	0.66	0.85	240	5.7	3.75	-	-	-	HP2	
		P8B28HP2	280	8	54	150	0.38	0.50	400	9.8	3.75	-	-	-	HP2	
		P8B30HP2	300	8	54	150	0.42	0.50	400	9.8	3.75	-	-	-	HP2	
		P9B30HP2F	300	9	54	-55 to 150	0.44	0.55	402	14.0	4.5 *1	72	-	-	-	HP2
		P10B28HP2	280	10	70	150	0.30	0.40	500	11.4	3.75	-	-	-	-	HP2
		P1R5B40HP2	400	1.5	35	150	4.2	5.0	120	3.9	3.75	-	-	-	-	HP2
		P4B40HP2	400	4	35	150	1.54	1.90	245	6.5	3.75	-	-	-	-	HP2
		P6B40HP2	400	6	54	150	0.84	1.05	400	10	3.75	-	-	-	-	HP2
		P9B40HP2	400	9	40	150	0.65	0.80	575	14.5	3.75	-	-	-	-	HP2
		P1B52HP2	525	1	35	150	6.0	7.2	125	4.3	3.75	-	-	-	-	HP2
		P2R5B52HP2F	525	2.5	35	150	2.5	3.2	240	6.7	3.25	52	-	-	-	HP2
		■ P5B50HP2F	500	5	54	-55 to 150	1.20	1.65	382	10.5	4.5 *1	72	-	-	-	HP2
		P5B52HP2	525	5	54	150	1.4	1.7	400	10.5	3.75	-	-	-	-	HP2
		P6B52HP2	525	6	70	150	1.10	1.35	520	15	3.75	-	-	-	-	HP2
		P0R5B60HP2	600	0.5	35	150	8.3	10.0	120	4.3	3.75	-	-	-	-	HP2
		P2B60HP2F	600	2	35	150	3.4	4.2	240	6.8	3.25	52	-	-	-	HP2
		P4B60HP2F	600	4	70	150	1.6	1.9	520	13	3.25	75	-	-	-	HP2
		★ P1B90VX3	900	1	TBD	150	9.5	14	193	10.8	3.5	-	○	○	○	VX3
		★ P2B90VX3	900	2	TBD	150	5.6	7.2	TBD	TBD	4 *1	-	○	○	○	VX3
TO-252AB similar SC-63 FE	G3-2	P1FE90VX3	900	1	36	-55 to 150	9.5	14.0	193	10.8	3.5	-	-	○	○	VX3

■ : New product ★ : Under development *1 : max.

THD (Through Hole Device)																	
JEDEC Code JEITA Code House Name	Fig.	Type No.	Absolute Maximum Ratings				Electrical Characteristics				Body Diode trr (typ) [ns]	Halogen free	Based on AEC-Q101	Automotive	Series		
			V _{DSS} [V]	I _D [A]	P _T [W]	T _{ch} [°C]	R _{DS(ON)} (typ) [Ω] V _{GS} =10V	R _{DS(ON)} (max) [Ω] V _{GS} =10V	C _{iss} (typ) [pF]	Q _g (typ) [nC]						V _{th} (typ) [V]	
- SC-91 FTO-220AG	J8-2	■ P36F25HP2	250	36	77	-55 to 150	0.08	0.12	1313	35	4.5 *1	-	-	-	HP2		
		P8F28HP2	280	8	52.5	-55 to 150	0.38	0.5	400	9.8	3.75	-	-	-	HP2		
		P13F28HP2	280	13	65	150	0.23	0.3	630	15	3.75	-	-	-	HP2		
		P17F28HP2	280	17	79	150	0.17	0.23	830	19.5	3.75	-	-	-	HP2		
		P21F28HP2	280	21	85	150	0.13	0.18	1000	20.5	3.75	-	-	-	■	HP2	
		P26F28HP2	280	26	90	150	0.11	0.15	1200	24.5	3.75	-	-	-	-	HP2	
		P36F28HP2	280	36	95	150	0.08	0.12	1730	35	3.75	-	-	-	-	HP2	
		P5F50HP2	500	5	52.5	150	1.3	1.6	400	10.5	3.75	-	-	-	-	HP2	
		P6F50HP2	500	6	62.5	150	1.00	1.25	500	12.5	3.75	-	-	-	-	HP2	
		P8F50HP2	500	8	65	150	0.8	1.0	610	15	3.75	-	-	-	-	HP2	
		P10F50HP2	500	10	79	-55 to 150	0.60	0.75	820	20	3.75	-	-	-	-	HP2	
		P13F50HP2	500	13	85	150	0.48	0.60	1050	25	3.75	-	-	-	-	HP2	
		P15F50HP2	500	15	90	150	0.4	0.5	1340	27	3.75	-	-	-	-	HP2	
		P20F50HP2	500	20	95	150	0.29	0.36	1735	40	3.75	-	-	-	-	■	HP2
		P3F60HP2	600	3	52.5	150	1.92	2.30	400	10	3.75	-	-	-	-	HP2	
		P4F60HP2	600	4	62.5	150	1.5	1.8	505	12.5	3.75	-	-	-	-	HP2	
		P5F60HP2	600	5	65	150	1.17	1.40	615	15	3.75	-	-	-	-	HP2	
		P7F60HP2	600	7	79	150	0.88	1.05	810	19	3.75	-	-	-	-	HP2	
		P10F60HP2	600	10	85	150	0.67	0.80	1040	23	3.75	-	-	-	-	HP2	
		★ P11F60EVA	600	11	57	-55 to 150	0.27	0.32	1815	32	4.5 *1	-	-	-	-	EVA	
		P12F60HP2	600	12	90	150	0.56	0.67	1230	26.5	3.75	-	-	-	-	HP2	
		P15F60HP2	600	15	95	-55 to 150	0.41	0.49	1750	37	3.75	-	-	-	-	HP2	
		P15F60HP2F	600	15	95	-55 to 150	0.44	0.53	1720	34	3.25	88	-	-	-	HP2	
		★ P16F60EVA	600	16	67	-55 to 150	0.18	0.22	2590	44	4.5 *1	-	-	-	-	EVA	
		★ P21F60EVA	600	21	77	-55 to 150	0.16	0.19	2970	48	4.5 *1	-	-	-	-	EVA	
		★ P25F60EVA	600	25	86	-55 to 150	0.13	0.15	3845	62	4.5 *1	-	-	-	-	EVA	
		■ P4F90VX3	900	4	79	150	2.8	3.6	595	21	4.0 *1	-	-	-	-	VX3	
■ P7F90VX3	900	7	95	150	1.2	1.7	1375	42	4.0 *1	-	-	-	-	VX3			
- SC-91 FTO-220A	J7-2	P23F40HP2FM	400	23	104	150	0.17	0.24	1620	40	3.25	68	-	-	-	HP2	
TO-247AD - MTO-3PV	K7-4	P30W60HP2V	600	30	310	-55 to 150	0.185	0.23	3935	70	3.75	-	-	-	-	HP2	
TO-247AD - GC	K8	■ P85GC28HP2F	280	85	430	-55 to 150	0.035	0.045	4375	110	4.5 *1	83	○	-	-	HP2	

■ : New product ★ : Under development *1 : max. ■ : Please contact us.

POWER MODULES

Power Modules include combinations of various power semiconductors. They are easy to design, reduce the number of components needed in the device, are suitable for device downsizing, and mitigate heat-dissipation concerns. At Shindengen, a multitude of packages allow us to meet customer needs of MOSFET, diodes, and other products. Semi customizable support and customizable package design support are available.

Transfer Type Package Sample

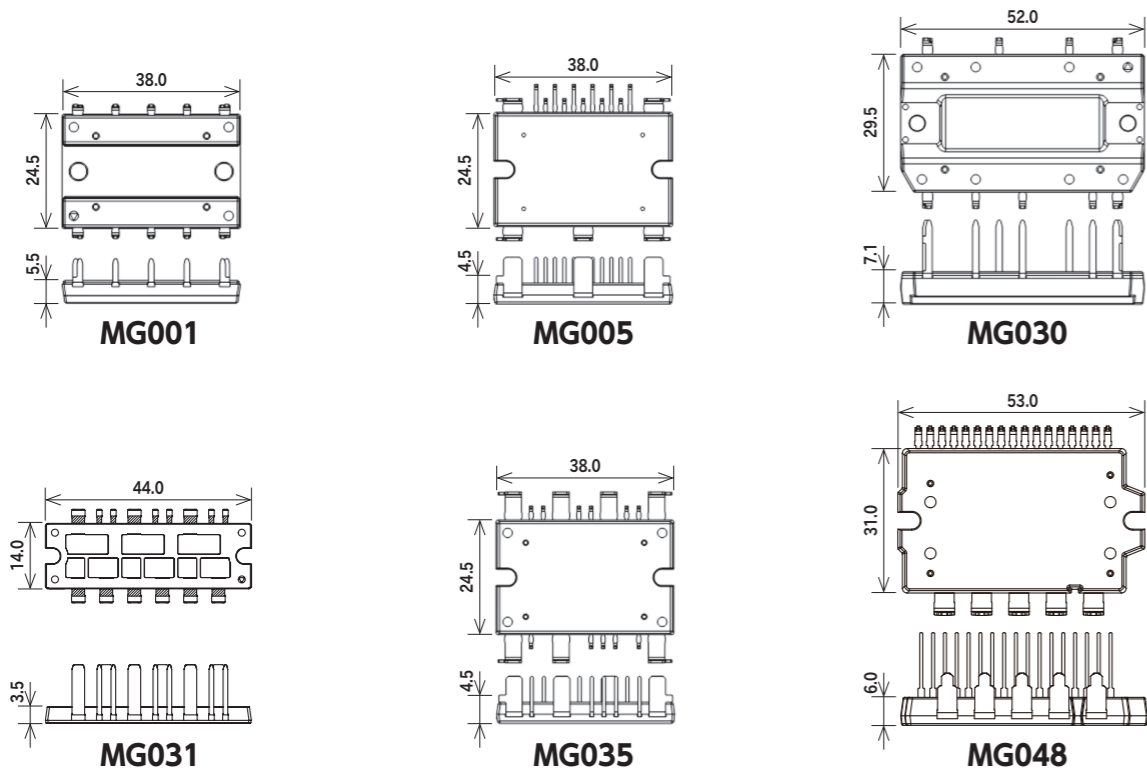

Potting Type Package Sample

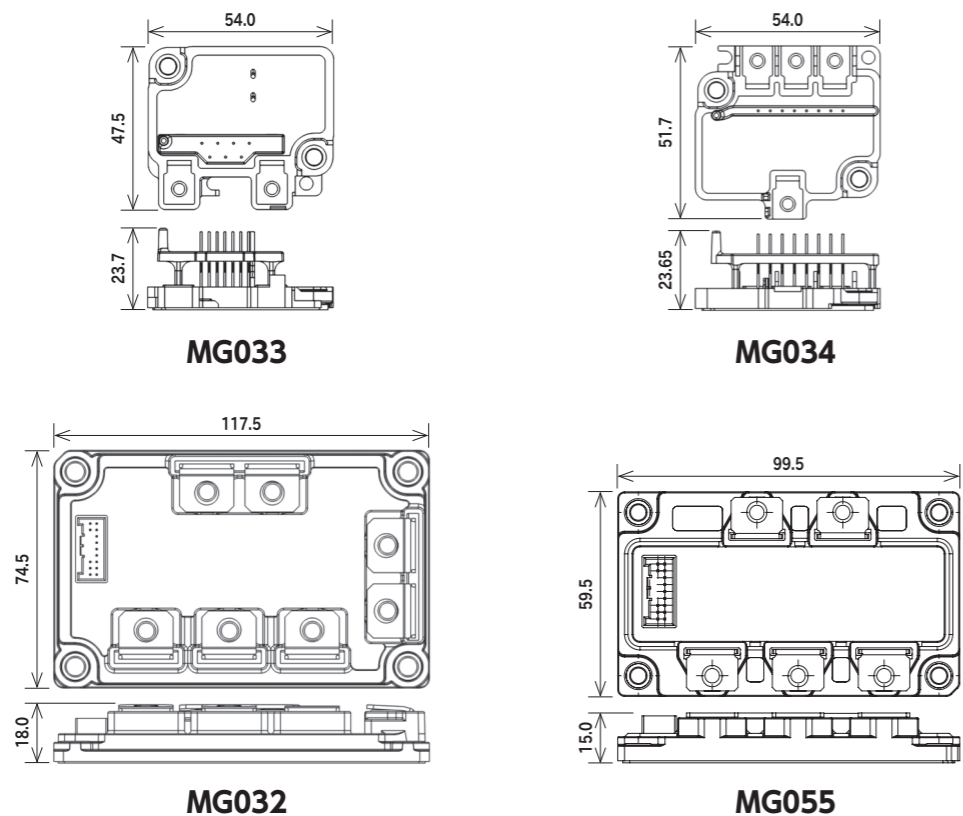

CB Module Series

Package		Type No.	Converter Diode					Brake IGBT				Brake FRD				Halogen free	UL	Automotive		
JEDEC Code	JEITA Code		Absolute Maximum Ratings			Electric Characteristics		Absolute Maximum Ratings		Electric Characteristics		Absolute Maximum Ratings		Electric Characteristics						
			VRRM [V]	IF (AV) [A]	Conditions Tc [°C]	Vf (max) [V]	Conditions IF [A]	VCES [V]	Ic [A]	VCE (sat) (typ) [V]	Conditions Ic [A]	VRRM [V]	IF (AV) [A]	Conditions Tc [°C]	Vf (max) [V]				Conditions IF [A]	ttr (max) [ns]
-	-	MG001AK028060A	600	20	137	1.05	7	600	28	1.70	28	600	3	137	1.65	3	50	○	UL	-
-	-	MG001AL030060A	600	30	136	1.05	10	600	30	1.5	30	600	3	137	1.65	3	50	○	UL	-

■ : New product UL : UL recognized (UL File No. E142422)

Equivalent Circuit Schematic

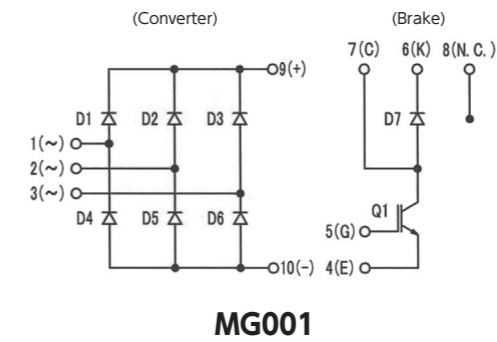

INV Module Series

Package		Type No.	Absolute Maximum Ratings					Electrical Characteristics						Halogen free	UL	Automotive
JEDEC Code	JEITA Code		Vdss [V]	Id [A]	Idp [A]	Pt [W]	Tch [°C]	Rds(on) (typ) [mΩ]	Rds(on) (max) [mΩ]	Ciss (typ) [pF]	Qg (typ) [nC]	Vth (typ) [V]	Rth(j-c) (max) [°C/W]			
-	-	MG031B090004A	40	90	360	125	175	2.34	3.2	4180	76	2.0	1.2	○	-	○
-	-	MG031E120004A	40	120	480	125	175	2.4	3.1	3297	61	3.0	1.2	○	-	○
-	-	MG031G148004A	40	148	592	154	175	1.75	2.2	5330	96	3.0	0.97	○	-	○
-	-	MG031L080006A	60	80	320	125	175	4.2	5.6	3381	60	3.0	1.2	○	-	○
-	-	MG031N110006A	60	110	440	154	175	2.9	3.8	5535	96	3.0	0.97	○	-	○
-	-	MG031MC148004A	40	148	592	154	175	1.75	2.2	5330	96	3.0	0.97	○	-	○
-	-	MG031MD110006A	60	110	440	154	175	2.9	3.8	5535	96	3.0	0.97	○	-	○
-	-	MG048A150004A	40	150	600	147	150	2.1	2.7	5900	111	3.0	0.85	○	-	■
-	-	MG048B100006A	60	100	400	147	150	2.92	3.65	8100	129	3.0	0.85	○	-	■
-	-	MG032A4207R5A	75	420	840	500	150	-	0.98	80120	505	3.0	0.25	-	-	○
-	-	MG032B420010A	100	420	840	500	150	0.99	1.37	91800	500	3.0	0.25	-	-	○
-	-	★ MG055A	75	420	840	TBD	150	0.63(chip)	TBD	TBD	TBD	3	TBD	-	-	○
-	-	★ MG055B	100	320	640	TBD	150	1.21(chip)	TBD	25480	500	3	TBD	-	-	○
-	-	★ MG055F	100	420	840	TBD	150	0.64(chip)	TBD	52910	840	3	TBD	-	-	○
-	-	★ MG055J	200	190	380	TBD	150	3.3(chip)	TBD	55050	799	3	TBD	-	-	○

■ : New product ★ : Under development ■ : Please contact us.

Equivalent Circuit Schematic

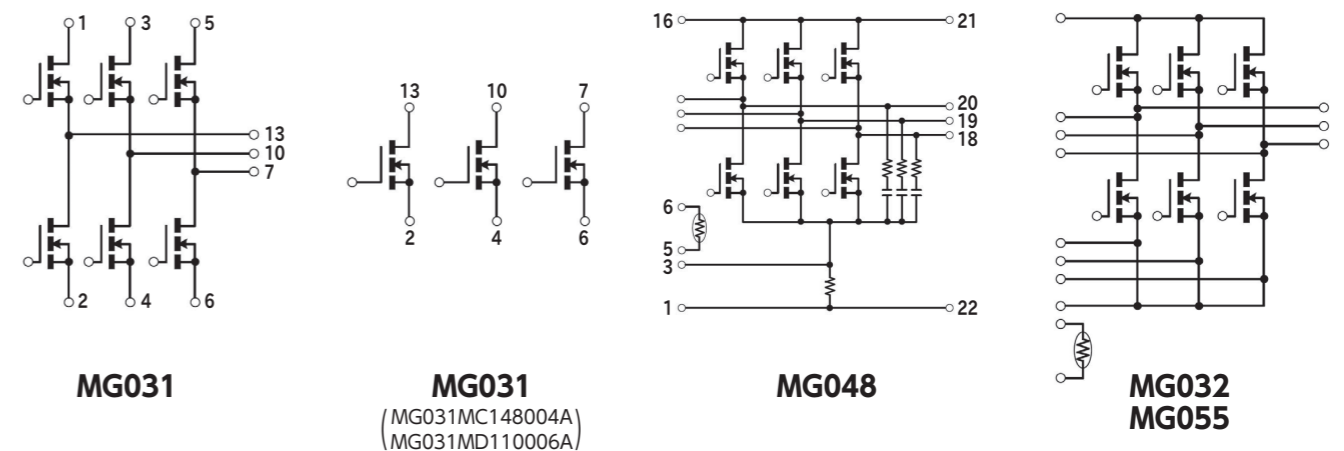

POWER ICs

Line up

IC for LED Lighting

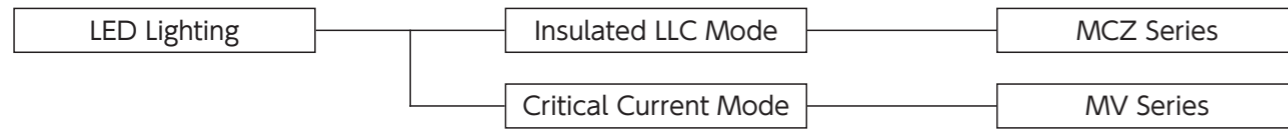

IC for Power Supply

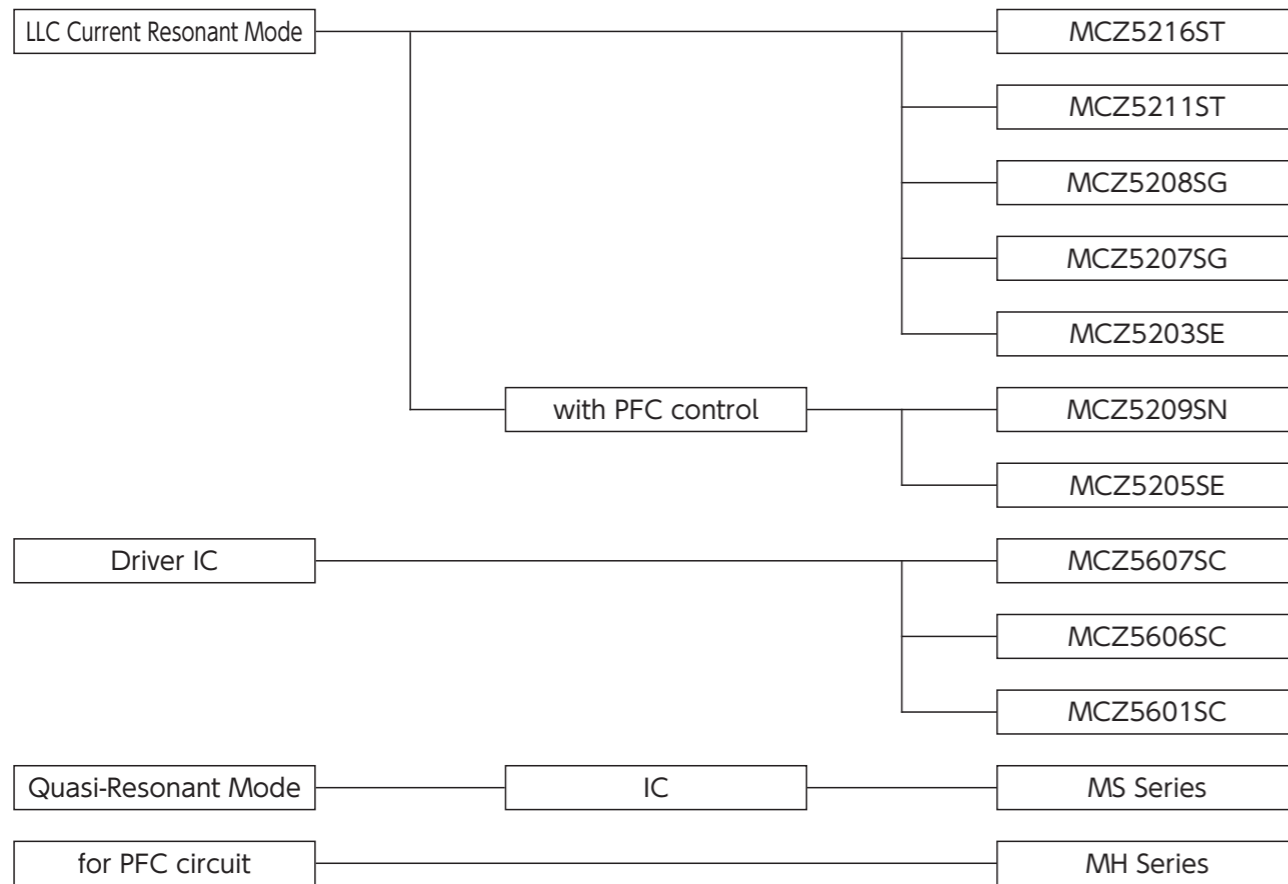

Ideal Diode IC

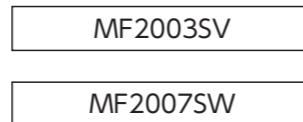



IC for LED Lighting

Current Mode Power Supply ICs for LED Lighting : MV Series

- Outline The MV series has a specialized function for LED lighting with PWM & Linear dimming that operates critical current mode without auxiliary winding. On and off width modulation function allows for smooth deep dimming of 1% or less.

MV Series

Critical Current Mode Power Supply ICs for LED Lighting

Package		JEDEC Code JEITA Code House Name	Fig.	Type No.	HV Startup	Vcc [V]	Output	ON/OFF	Built-in Regulator Voltage [V]	Linear Dimming	PWM Dimming	Halogen free	Automotive
	— SOP8J												
				MV1002SC	No	—	—						
				MV1011SC	Yes	—	—						
				MV1012SC	No	—	—						
	— SOP16		L5	MV2002SG	No	10 to 16	2ch	Cont. by REF Voltage	3.3	Yes	Yes	—	—
				MV2052SG	No				5			—	—

POWER ICs

IC for Power Supply

LLC Current Resonant Mode Controller ICs for Bridge Converter : MCZ Series

- Outline** The MCZ series is an advanced symmetric LLC current resonant mode controller for bridge converters. Symmetric LLC resonant converter applications are greatly expanding due to their extremely high efficiency and low noise characteristics.

High/Low Side Driver IC

- Outline** A driving IC for MOSFET and IGBT power devices. With built-in high-withstand voltage components, it can be used for a variety of uses such as inverter and power supply, etc.

Low Power Standby Quasi-Resonant Power Supply ICs : MS Series

- Outline** The MS series consumes much less power in standby mode. The ICs incorporate various functions to make it more user-friendly and easier to design a power supply with fewer external components.

PFC ICs : MH Series

- Outline** The MH series is a PFC circuit control IC which enables multistage interleave. An efficient, high power operation is possible by utilizing a follower IC composed of multistage interleave and a leader IC that can be used alone.







Ideal Diode IC

Ideal Diode IC V-Diode™ MF Series

- Outline** This is an ideal diode IC with a built-in reverse connection and reverse current protection it is used for electronic units with batteries as input sources. By using a built-in or a separate MOSFET to control the IC, it allows reducing the size of the circuit board as well as lowering loss and increasing heat dissipation.



MCZ Series

LLC Current Resonant Mode Controller ICs for Bridge Converter

Package		Type No.	Type	HV Startup	High-side Drive	Vcc (max) [V]	Vin Sensing	Burst Mode	Maximum Frequency [kHz]	X-cap. discharge	Capacitive Mode Protection	Over Voltage Protection	Over Current Protection	Halogen free	Automotive															
JEDEC Code JEITA Code House Name	Fig.																													
	—	L6	 MCZ5216ST	LLC Current Resonant Mode	Yes	35	Yes	Yes	500	Yes	Yes	Latch	Timer Latch	○	—															
	SOP18		 MCZ5211ST	LLC Current Resonant Mode	Yes			Yes	500	No				○	—															
	—	L8	MCZ5209SN	LLC Current Resonant Mode with PFC Control	Yes			35	Yes	Yes				300	No	Yes	Latch	Timer Latch	○	—										
	SOP24		MCZ52075G	LLC Current Resonant Mode	No					Yes				300	No				—	—										
	—	L5	MCZ5208SG	LLC Current Resonant Mode	No					35				Yes	Yes				500	No	Yes	Latch	Timer Latch	○	—					
	SOP16		MCZ52055E	LLC Current Resonant Mode with PFC Control	No										No				300	No				—	—					
	—	L7	MCZ5205SE	LLC Current Resonant Mode with PFC Control	No										35				Yes	No				300	No	Yes	Latch	Timer Latch	—	—
	SOP22		MCZ52035E	LLC Current Resonant Mode	No															No				300	No				—	—
	—	L7	MCZ52035E	LLC Current Resonant Mode	No	35	Yes				No	300	No							Yes				Latch	Timer Latch				—	—
	SOP22		MCZ52035E	LLC Current Resonant Mode	No						No	300	No																—	—

 : New product

High/Low Side Driver ICs

Package		Type No.	Output	High-side Floating Supply Voltage [V]	Vcc (max) [V]	Input/Output Channel	Vcc_UVLO [V]	VBS_UVLO [V]	Source [mA]	Sink [mA]	Halogen free	Automotive	
JEDEC Code JEITA Code House Name	Fig.												
	—	L2	High-side/ Low-side	622	22	2/2	8.2 to 8.9	8.2 to 8.9	220	450	○	—	
	SOP8J			 MCZ56065C	622	22	2/2	8.2 to 8.9	8.2 to 8.9	220	450	○	—
				 MCZ56015C	600	22	2/2	8.2 to 9.0	7.2 to 8.0	400	400	○	—

 : New product

MS Series

Low Power Standby Quasi-Resonant Power Supply ICs

Package		Type No.	Vin [V]	Vcc [V]	Over Voltage Protection	Over Current Protection	Stand-by Operation	Bottom Skip	Halogen free	Automotive	
JEDEC Code JEITA Code House Name	Fig.										
	—	L3	95 to 450	11 to 21	Auto restart	Auto restart	Auto Burst Mode	1 skip	○	—	
	SOP8/7J			MS1004SH	11 to 24	Vcc Latch	Timer Latch 2sec. (typ)	Auto Burst Mode/ S-Stby Mode	2 skip	—	—
				MS1003SH	11 to 24	Vcc Latch	Timer Latch 2sec. (typ)	Auto Burst Mode/ S-Stby Mode	1 skip	—	—

 : New product



MH Series



PFC ICs

Package		Type No.	Type	Operation Mode	Vin Sensing	Vcc [V]	Zero Current Detection	Diodes Short Protection	FB Open Short Protection	Over Voltage Protection	Halogen free	Automotive
JEDEC Code JEITA Code House Name	Fig.											
	—	L2	MH2501SC	Critical Current Mode	Leader	13 to 23	Auxiliary Winding	Yes	Yes	Yes	—	—
	SOP8J		MH2511SC	Synchronizes with Leader IC	Follower		Unnecessary	11 to 23	No	No	No	—









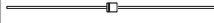
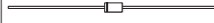
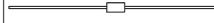
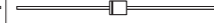

MF Series

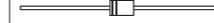
Ideal Diode IC

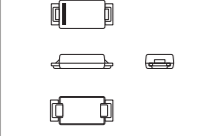
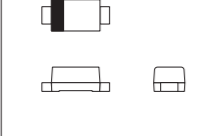
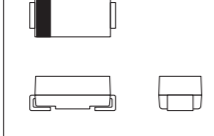
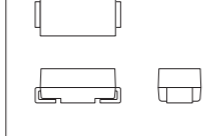
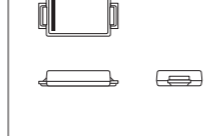
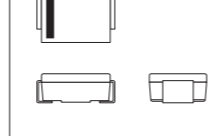
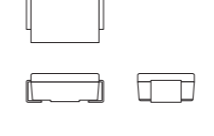
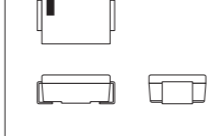
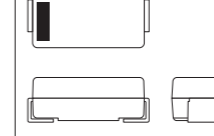
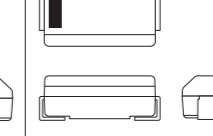
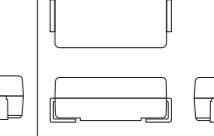
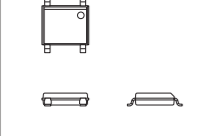
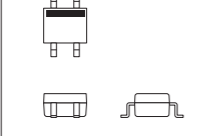
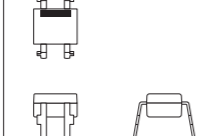
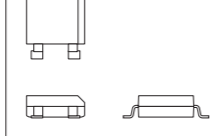
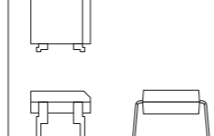
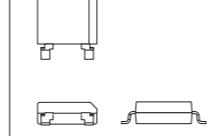
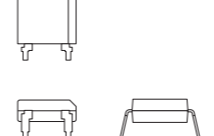
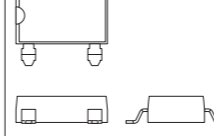
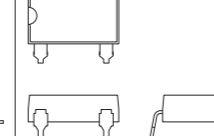
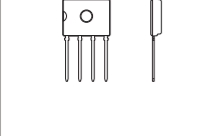
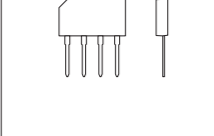
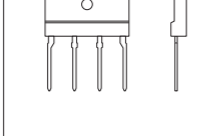
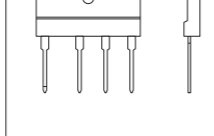
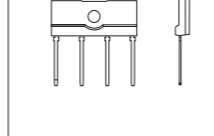
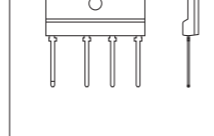
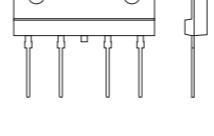
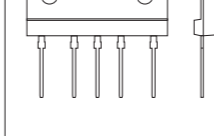
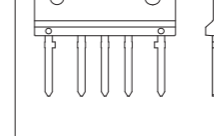
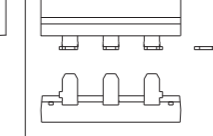
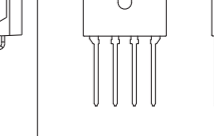
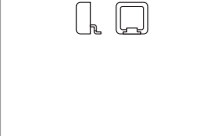
Package		Type No.	Featured Type	Operating Voltage [V]	Reverse Connection Protection	Reverse Current Prevention	Ron(typ.) [mΩ]	Quiescent Current/ Shutdown Supply Current	Halogen free	Automotive
JEDEC Code JEITA Code House Name	Fig.									
	—	L9	Built-in Pch MOSFET	2.5 to 40	Yes	Yes	53	Quiescent Current = 3μA	○	○
	WSON8									
	—	L10	Driver IC for Separate Nch MOSFET	4.5 to 70	Yes	Yes	—	Shutdown Supply Current = 5μA	Not identified	○
	TSSOP10									

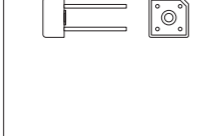
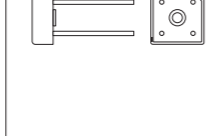
 : New product  : Under development

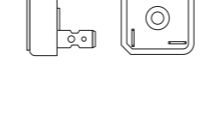
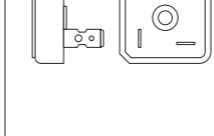
PACKAGE LIST

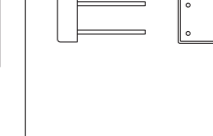
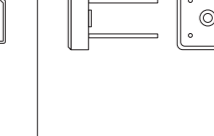
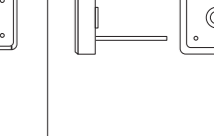
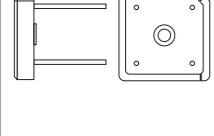
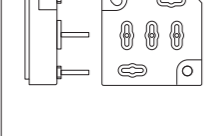
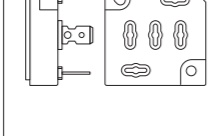
	1	2	3	4	5	6	7	8	9	10	11	12
A	A1 Package:AX057 	A2 Package:AX06 	A3 Package:AX06 	A4 Package:AX078 	A5 Package:AX10 	A6 Package:AX10 	A7 Package:AX14 					
B	B1 Package:DO-219AB similar 	B2 Package:DO-219AA 	B3 Package:DO-214AC 	B4 Package:DO-214AC 	B5 Package:SC-110B 	B6 Package:DO-214AA similar 	B7 Package:DO-214AA similar 	B8 Package:DO-214AA similar 	B9 Package:2F 	B10 Package:2F 	B11 Package:2F 	
C	C1 Package:SOPA-4 	C2 Package:TO-269AA 	C3 Package:1Z (DIP) 	C4 Package:1N (SMD) 	C5 Package:1N (DIP) 	C6 Package:1NA (SMD) 	C7 Package:1NA (DIP) 	C8 Package:1W (SMD) 	C9 Package:1W (DIP) 			
D	D1 Package:D3K 	D2 Package:2S 	D3 Package:3S 	D4 Package:5S 	D5 Package:JB 	D6 Package:JA 	D7 Package:TSB(4pin)JC(4pin) 	D8 Package:TSB(5pin)JC(5pin) 	D9 Package:JF 	D10 Package:JH 	D11 Package:D6K 	
E	E1 Package:MCP 	E2 Package:D30VC 	E3 Package:S2VB 	E4 Package:S4VB 	E5 Package:S5VB 	E6 Package:S10VB 	E7 Package:S15VB 	E8 Package:S25VB 	E9 Package:S50VB 	E10 Package:S3WB 	E11 Package:S10WB 	E12 Package:S15WB 
	13	14	15									
E	E13 Package:S20WB 	E14 Package:SVTA 	E15 Package:SVT 									

PACKAGE LIST

	1	2	3	4	5	6	7	8	9	10	11	12
F	F1 Package:Module 	F2 Package:Module 	F3 Package:Module 	F4 Package:MG001 	F5 Package:MG031 	F6 Package:MG032 	F7 Package:MG038 	F8 Package:MG048 	F9 Package:MG060 	F10 Package:MG061 	F11 Package:MG055 	
G	G1 Package:SC-63 E-pack 	G2 Package:TO-252AA EB 	G3 Package:TO-252AB similar EE 	G4 Package:DO-277A similar EY 	G5 Package:TO-252AA similar EB 	G6 Package:LA 	G7 Package:MO-235B similar LE 	G8 Package:LF_Dual 				
H	H1 Package:SC-83 similar ETO-220 	H2 Package:SC-83 similar EY 		H4 Package:TO-263AB EES 		H6 Package:TO-263AB EY 	H7 Package:TO-263-SC EY,ZP 					
J	J1 Package:SC-91A ETO-220(2pin) 	J2 Package:SC-91 ETO-220A(2pin) 	J3 Package:SC-91 ETO-220AG(2pin) 	J4 Package:SC-91 ETO-220G(2pin) 		J6 Package:SC-91A ETO-220(3pin) 	J7 Package:SC-91 ETO-220A(3pin) 	J8 Package:SC-91 ETO-220AG(3pin) 	J9 Package:SC-91 ETO-220G(3pin) 			
K		K2 Package:TO-247AD MTO-3P(2pin) 		K4 Package:TO-247AD MTO-3P(3pin) 	K5 Package:TO-247AD MTO-3P(3pin) 	K6 Package:TO-247AD MTO-3PV 	K7 Package:TO-247AD MTO-3PV 	K8 Package:TO-247AD GC 				
L	L1 Package:SOP8 	L2 Package:SOP8J 	L3 Package:SOP8/7J 		L5 Package:SOP16 	L6 Package:SOP18 		L7 Package:SOP22 	L8 Package:SOP24 	L9 Package:WSON8 	L10 Package:TSSOP10 	

OUTLINE DIMENSIONS

[Unit:mm]

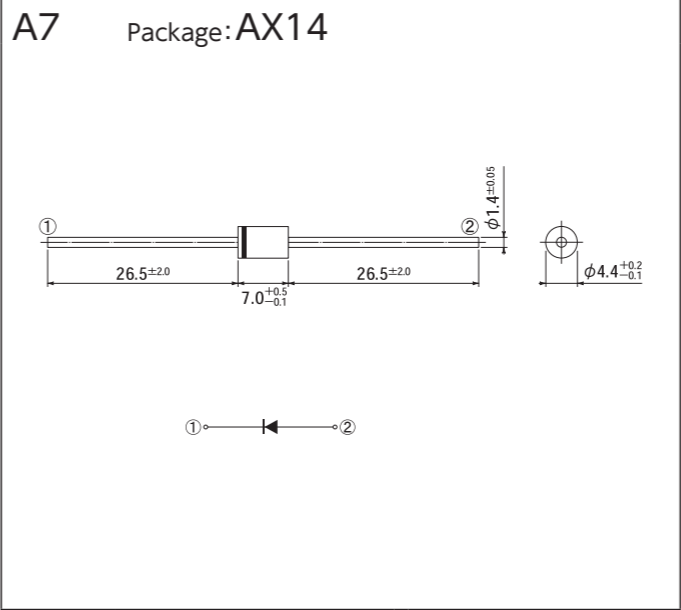
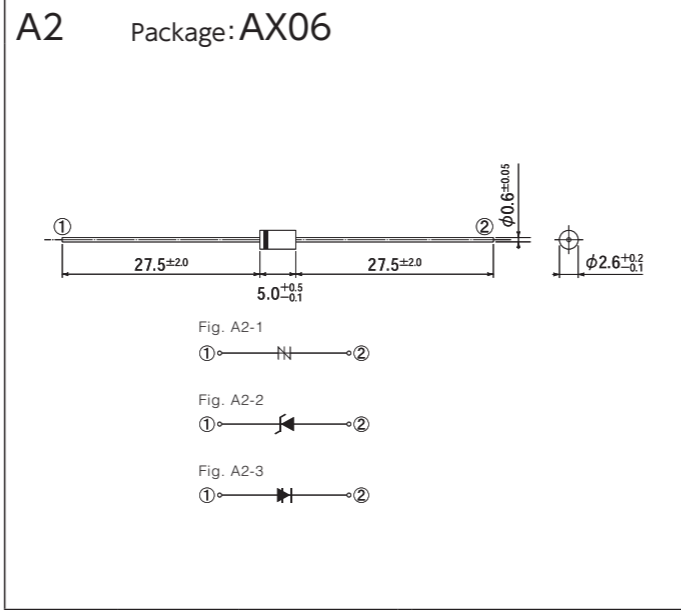
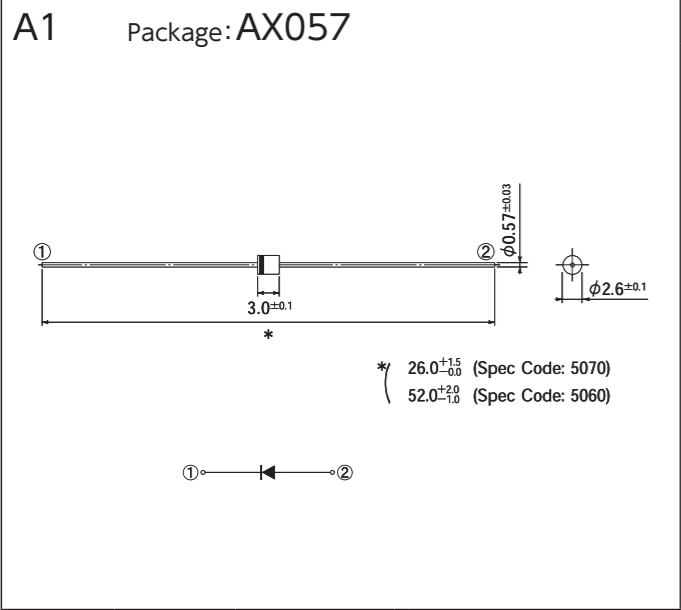

[Unit:mm]

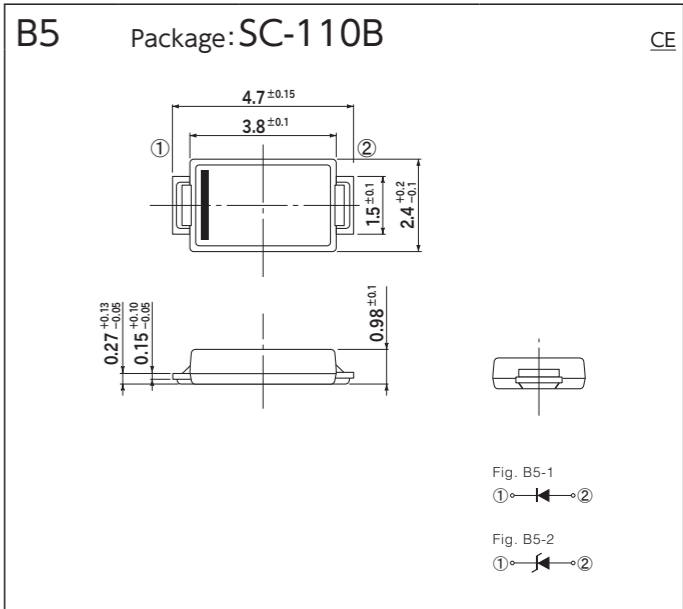
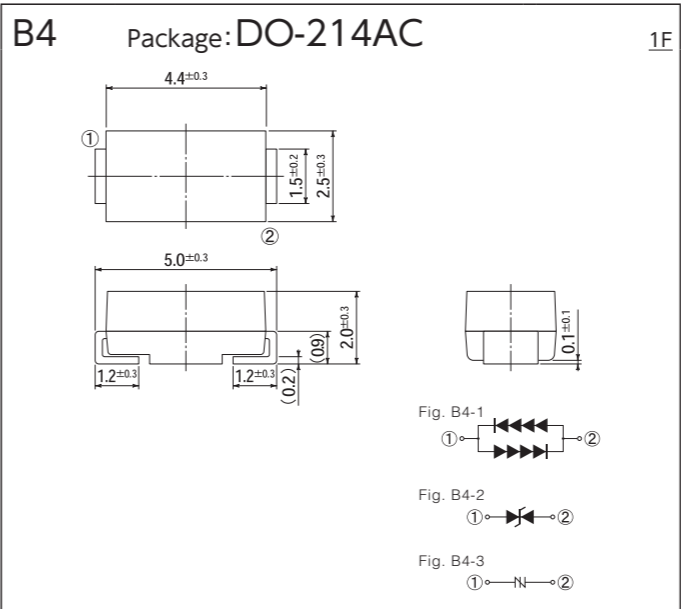
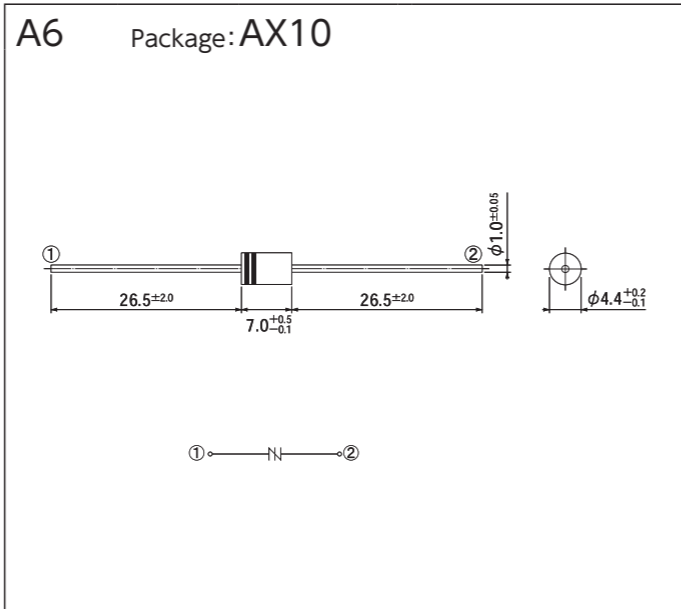
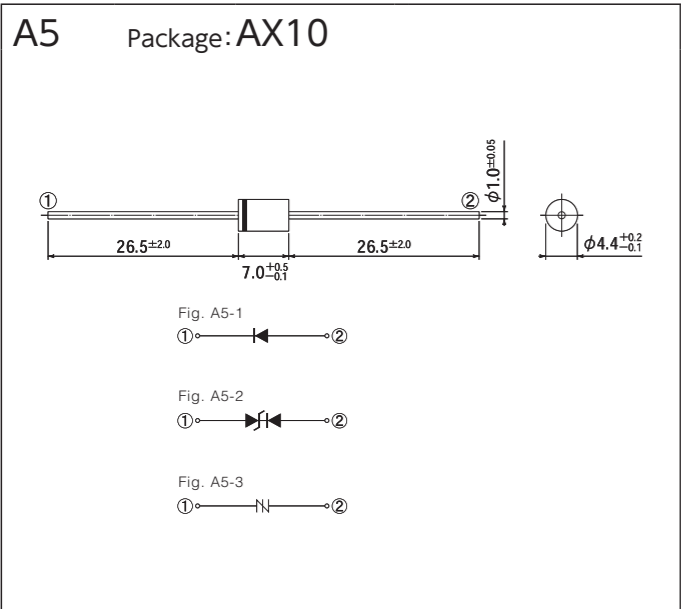
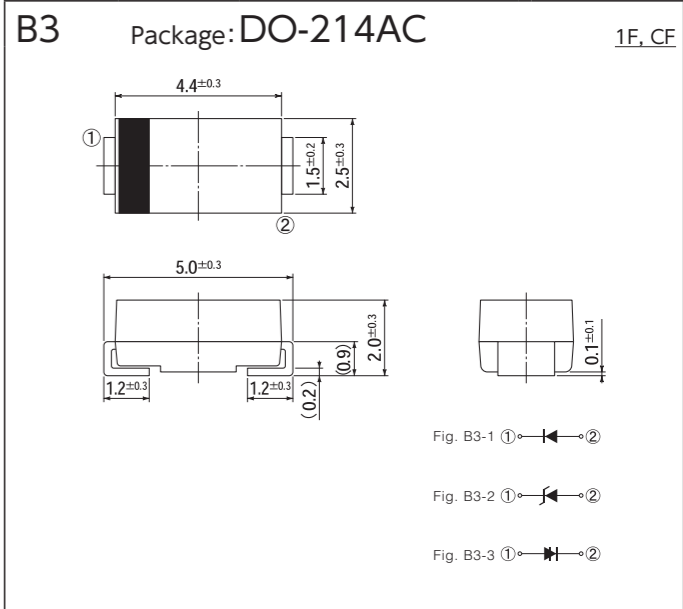
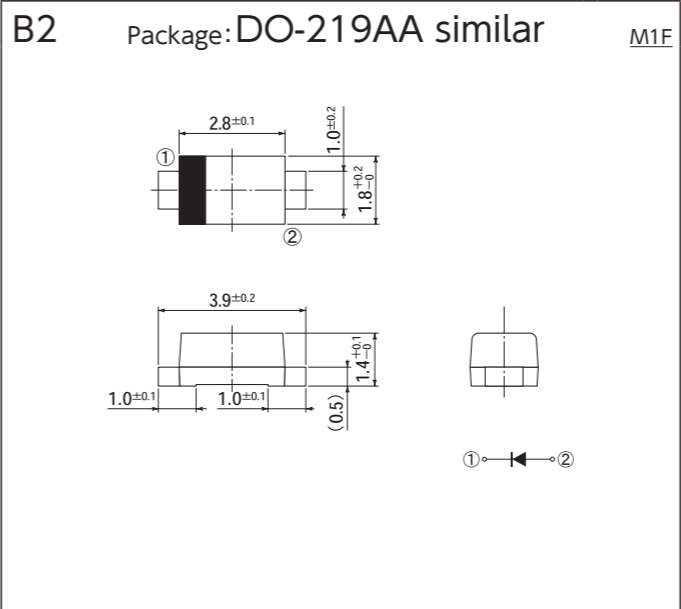
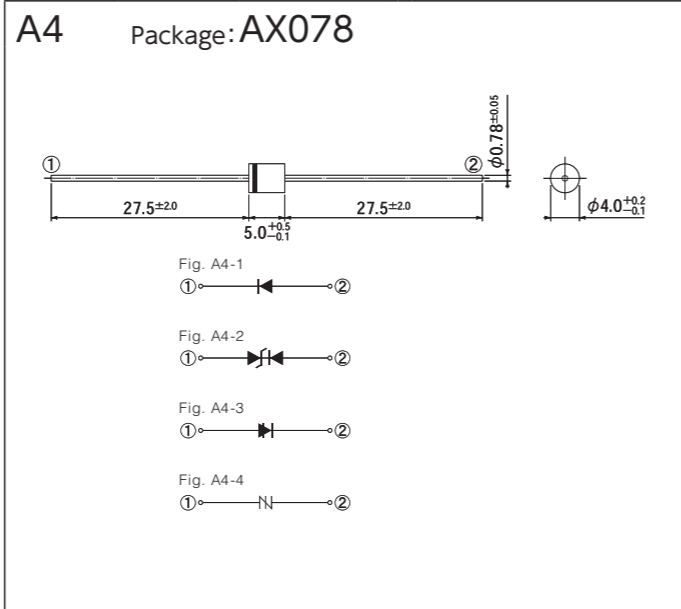
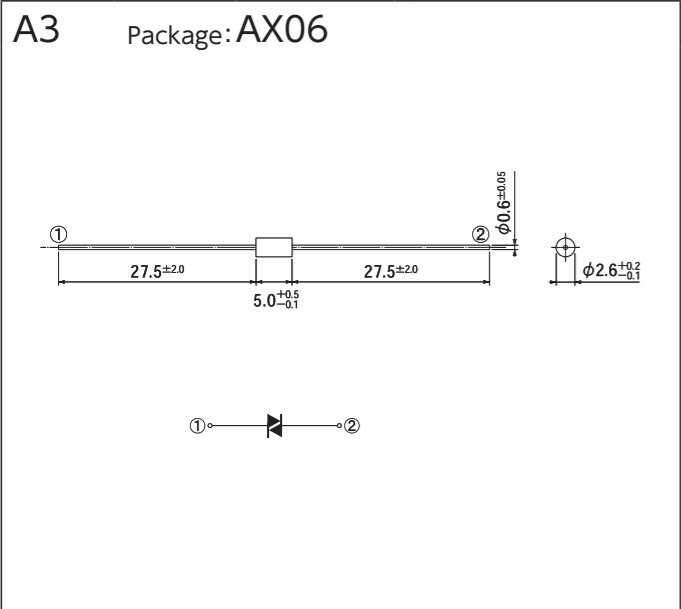
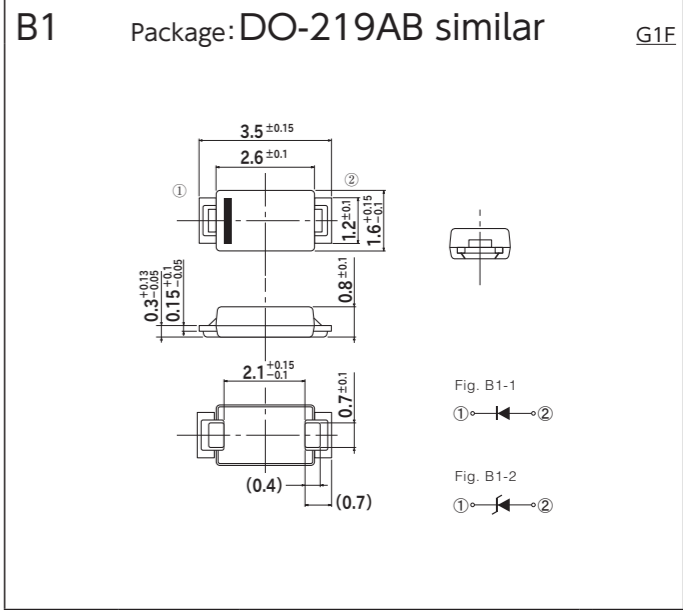

OUTLINE DIMENSIONS

[Unit:mm]

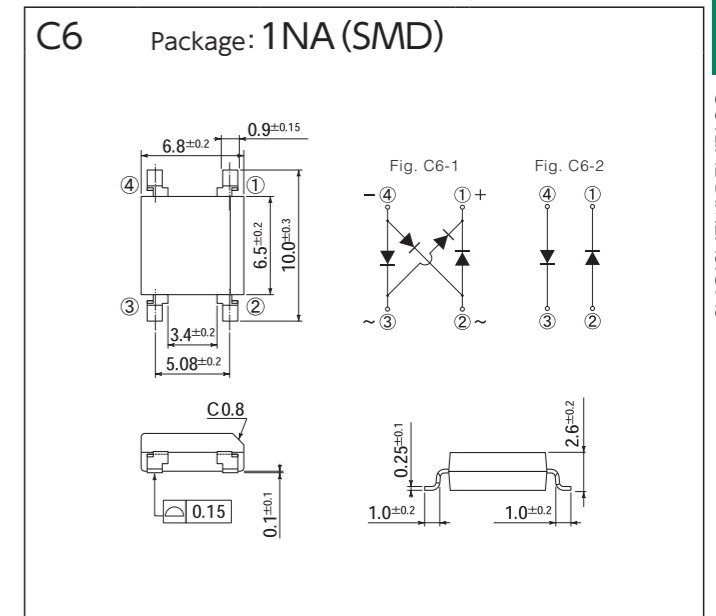
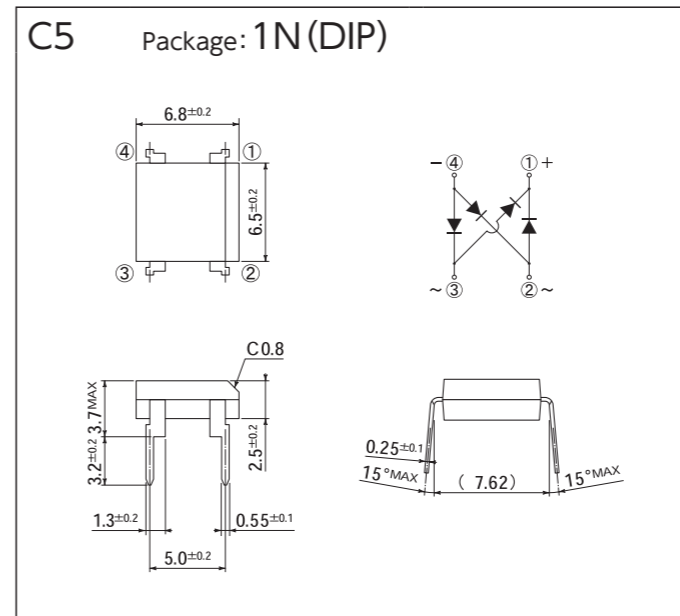
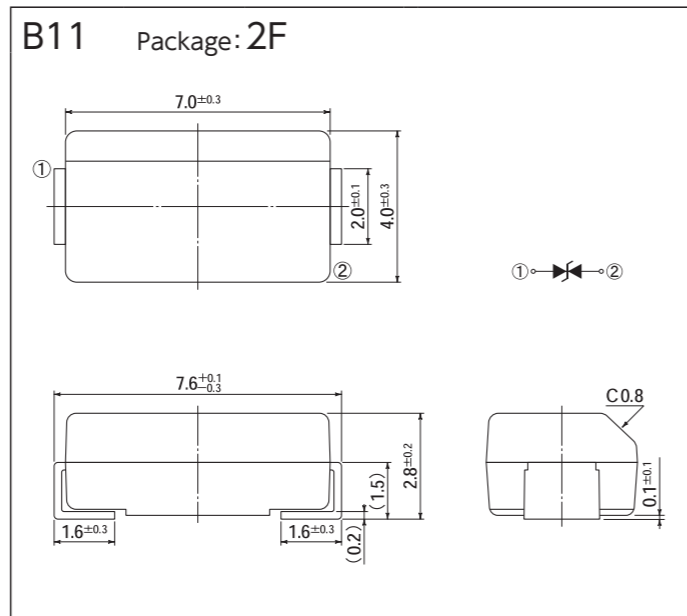
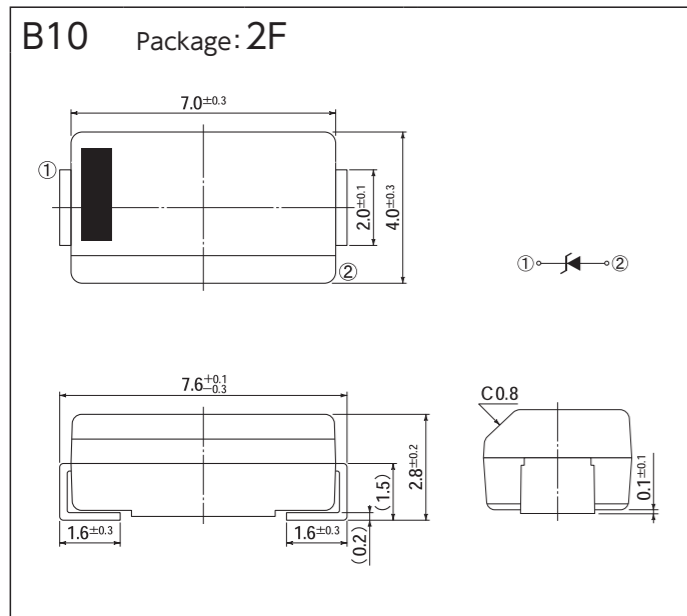
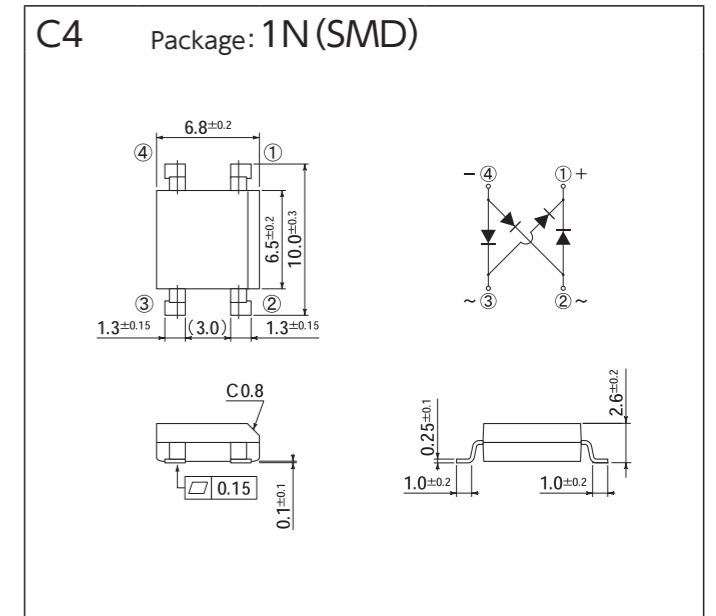
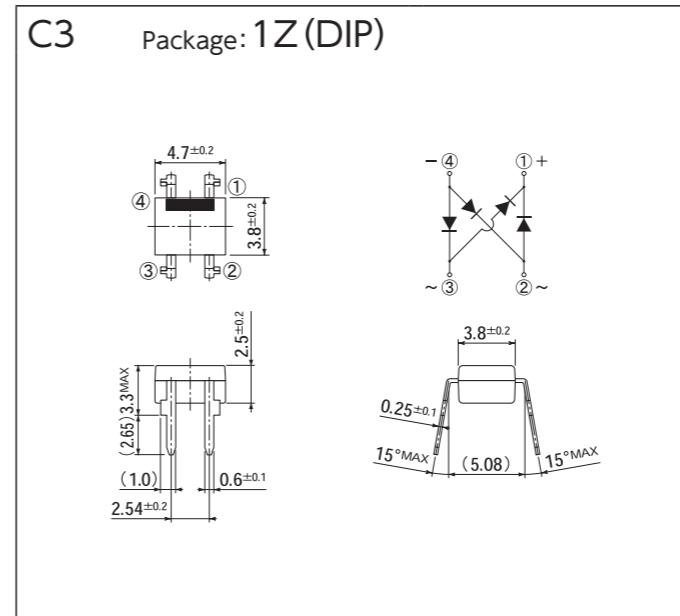
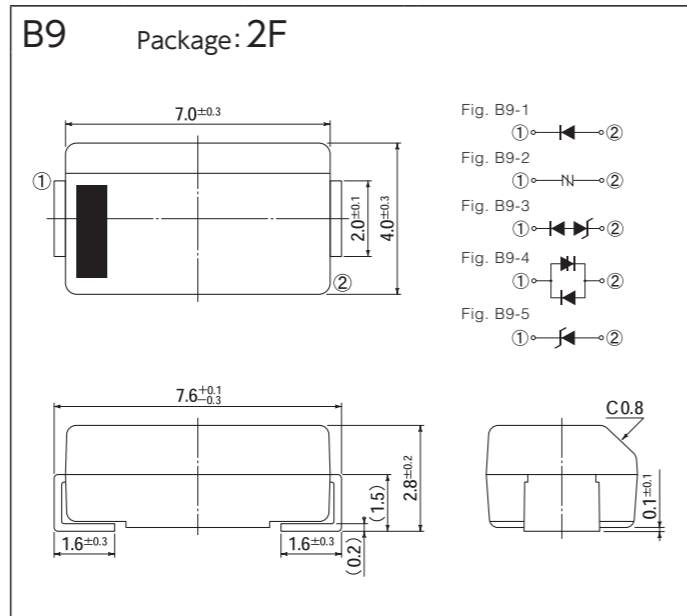
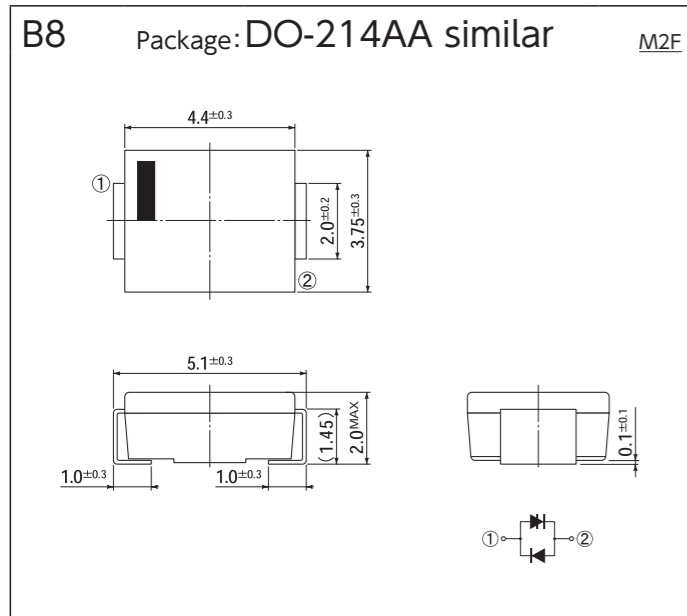
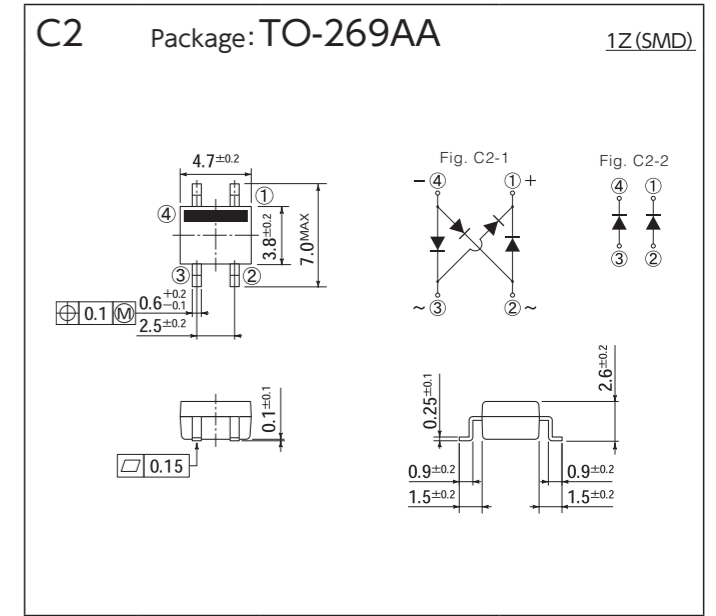
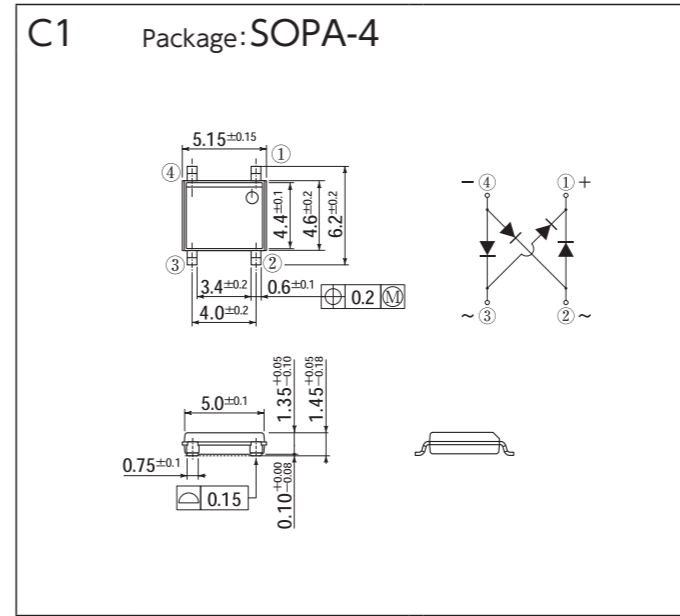
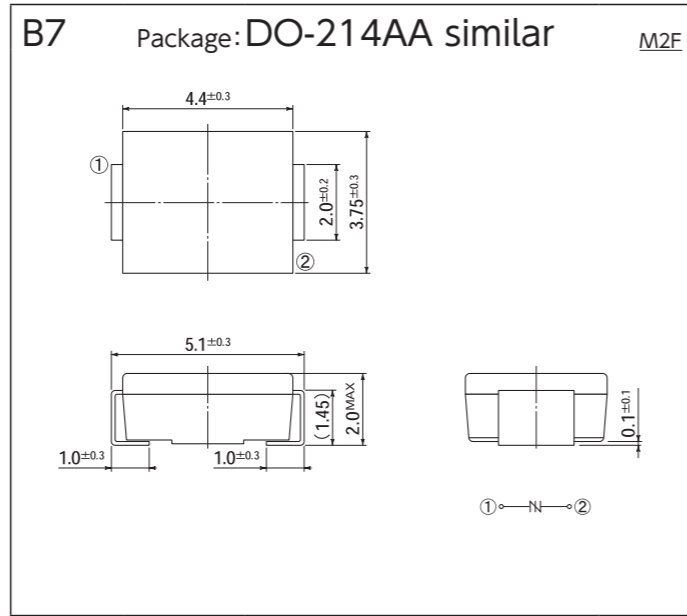
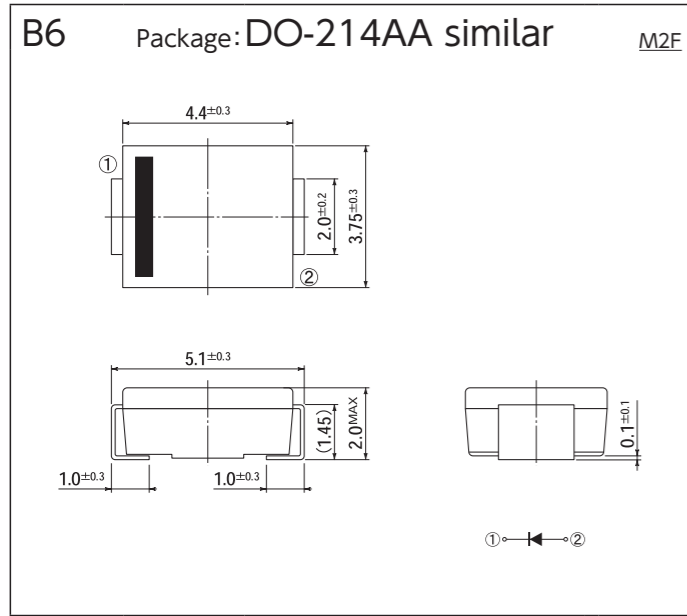

OUTLINE DIMENSIONS

[Unit:mm]

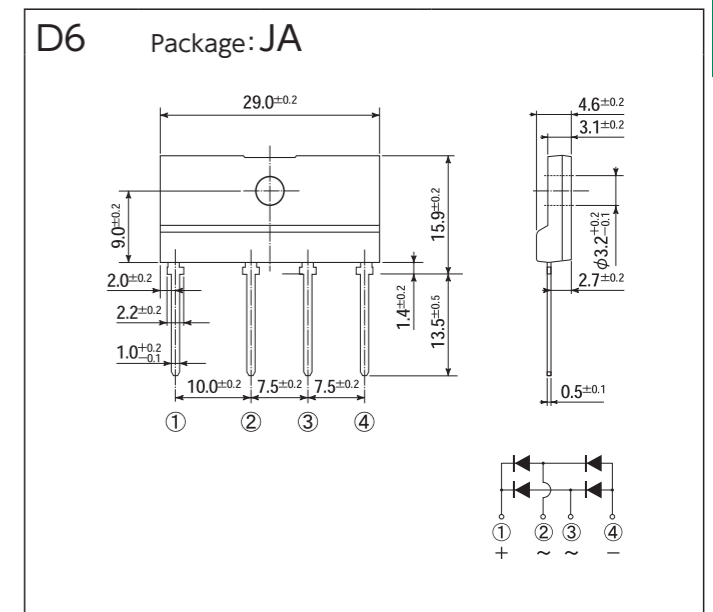
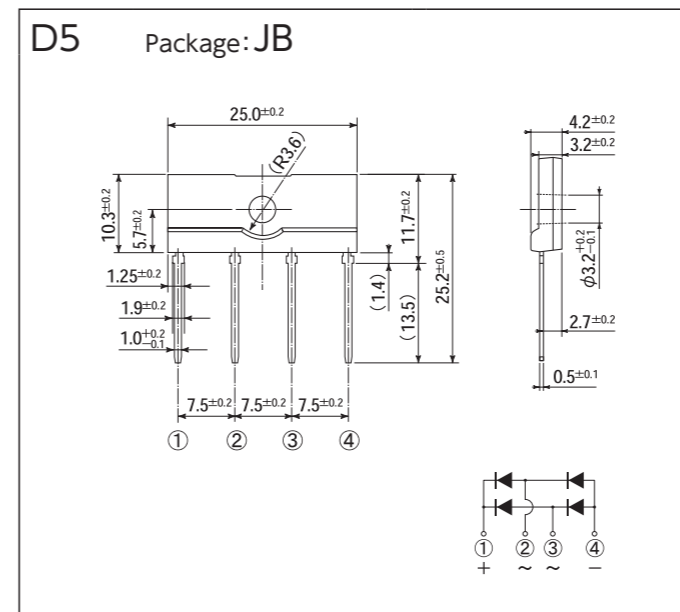
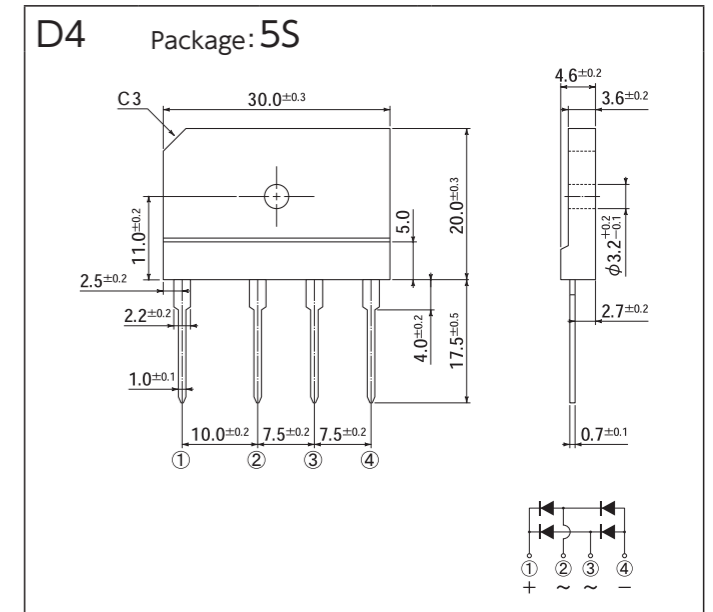
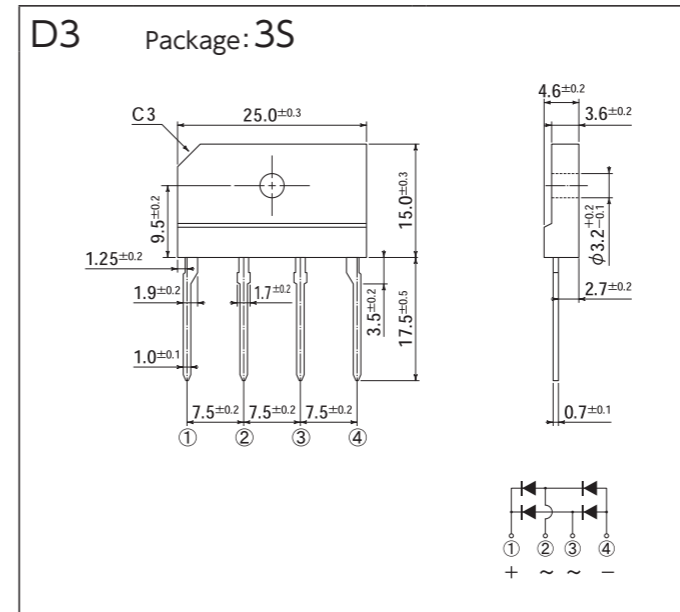
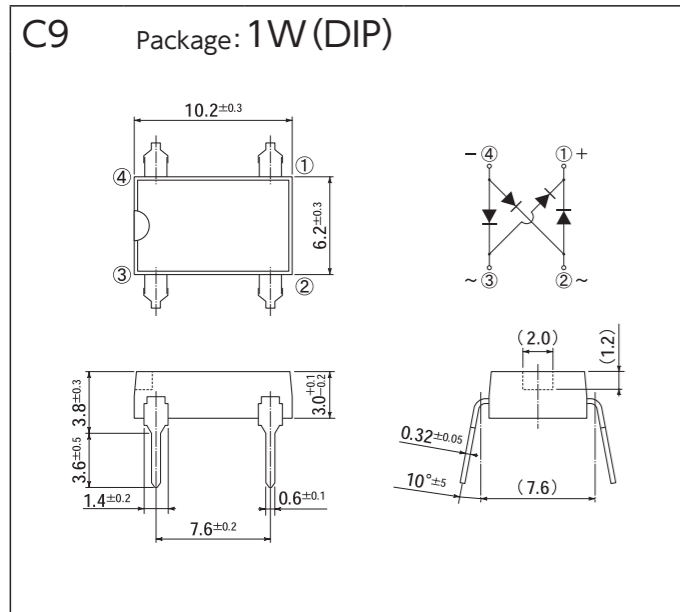
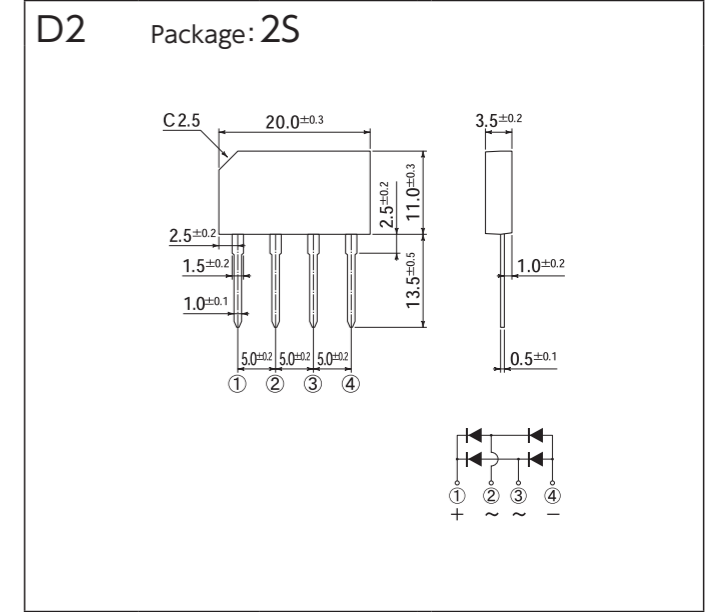
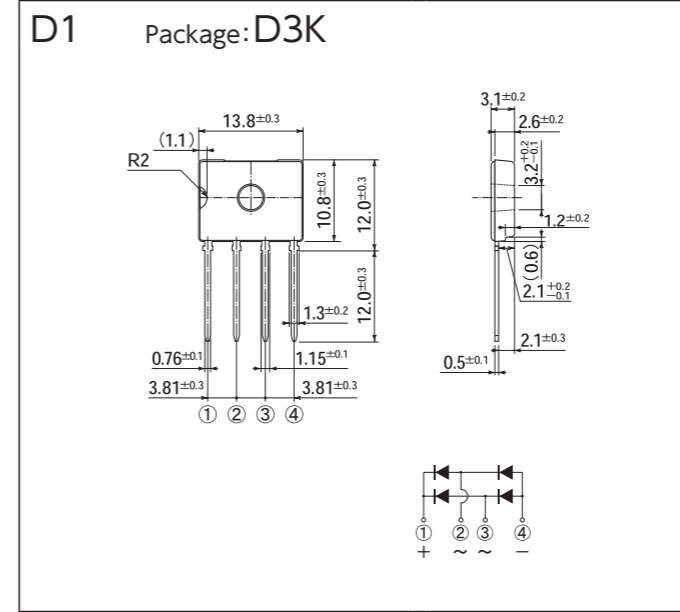
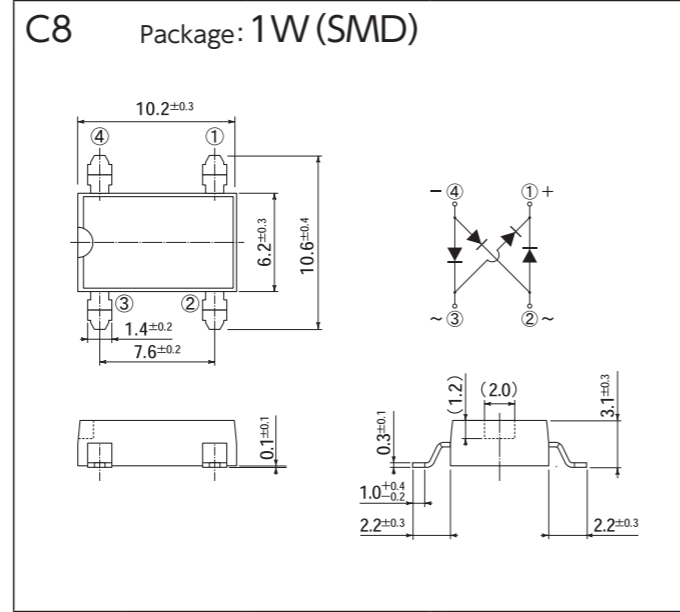
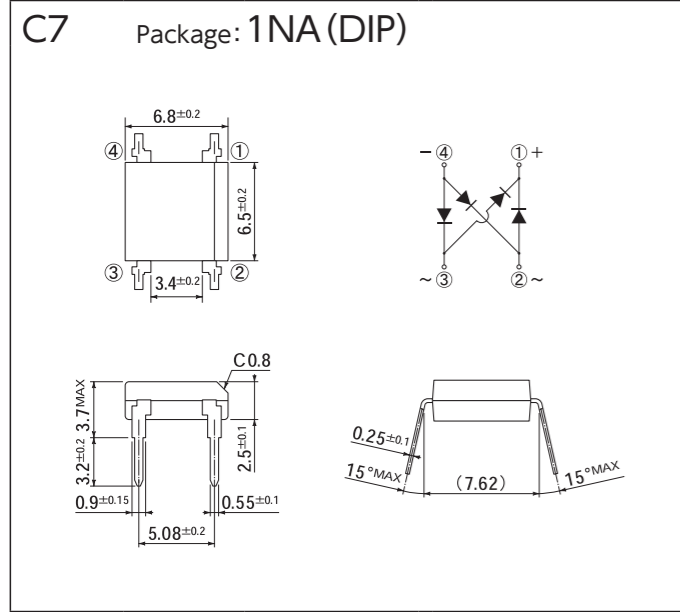

OUTLINE DIMENSIONS

OUTLINE DIMENSIONS

[Unit:mm]

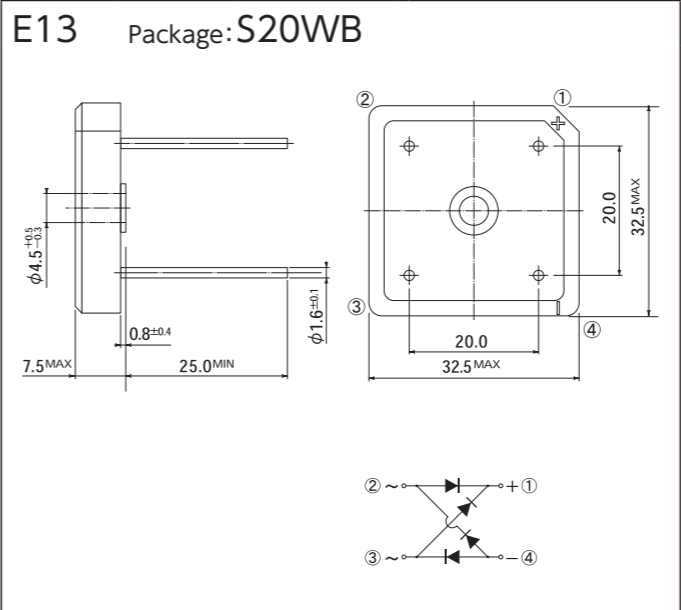
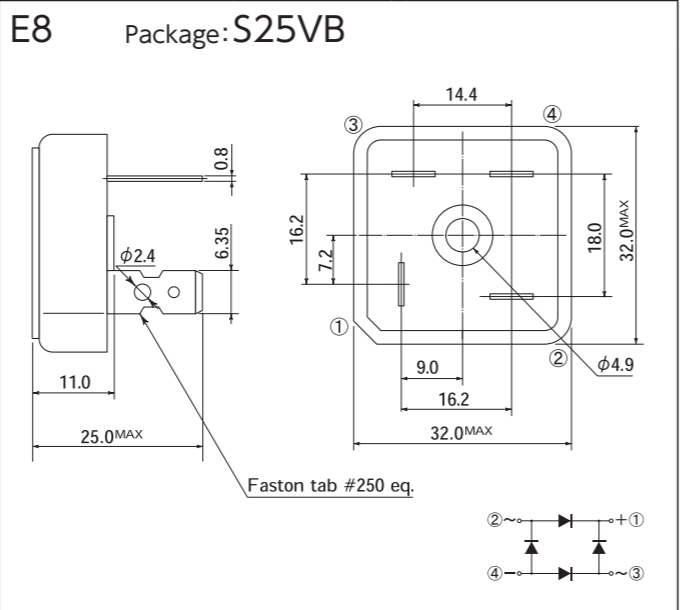
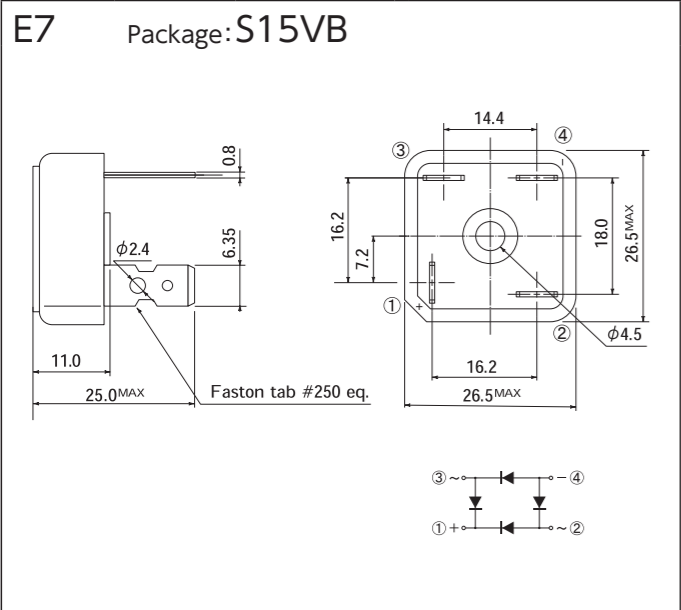

[Unit:mm]

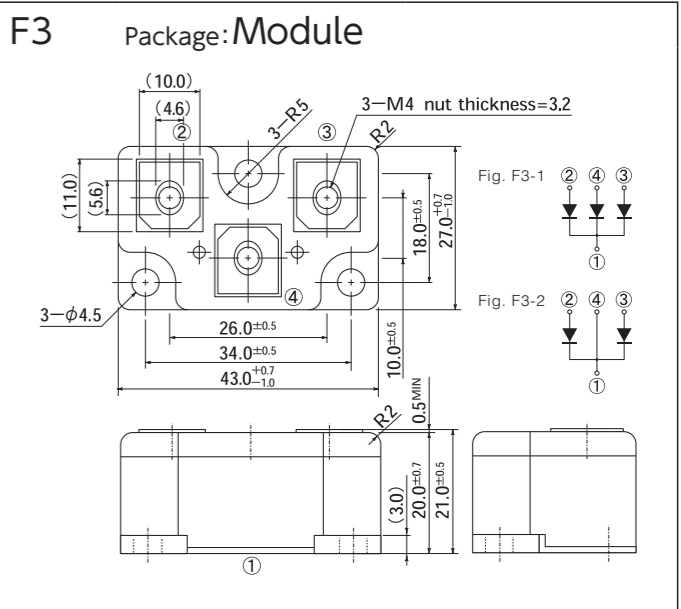
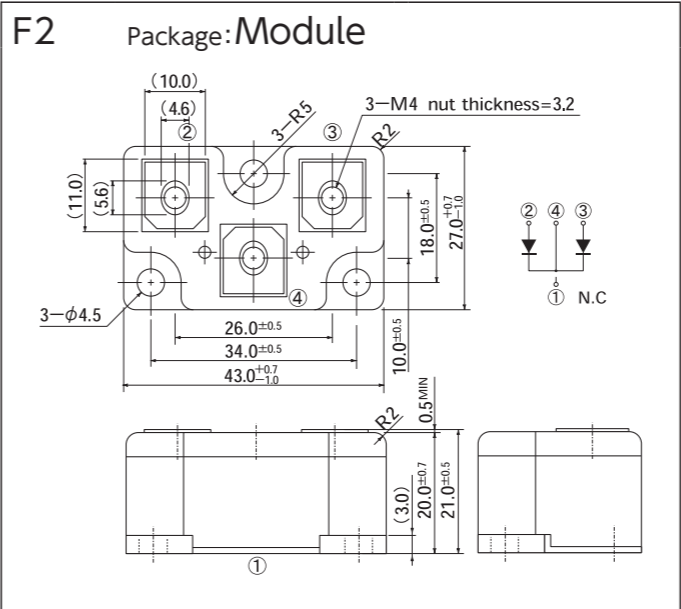
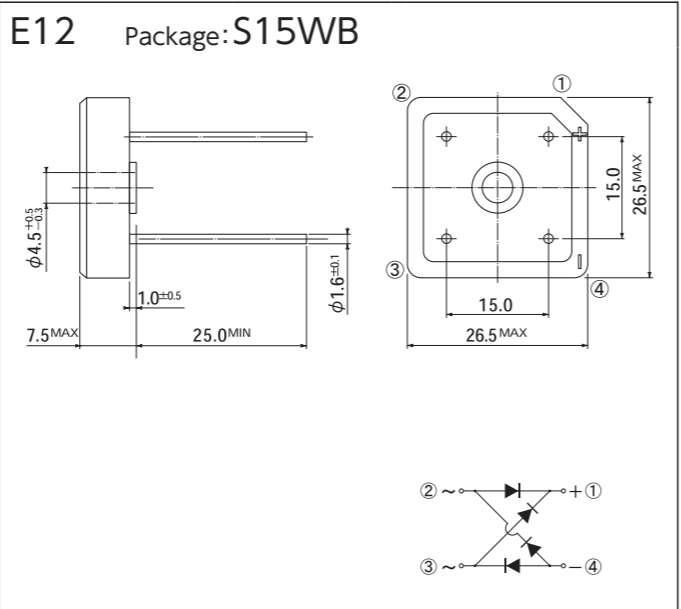
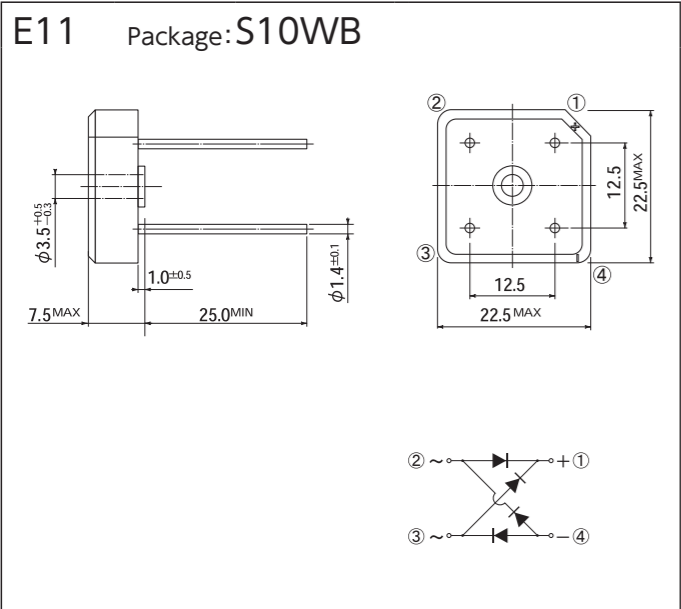
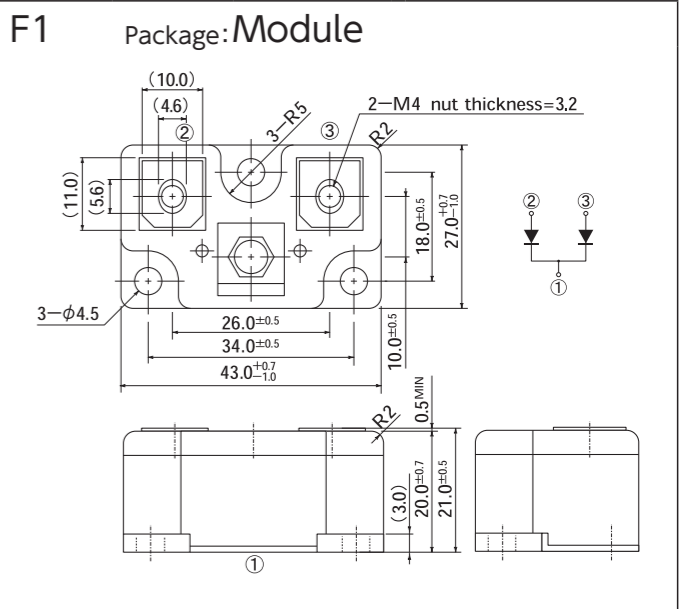
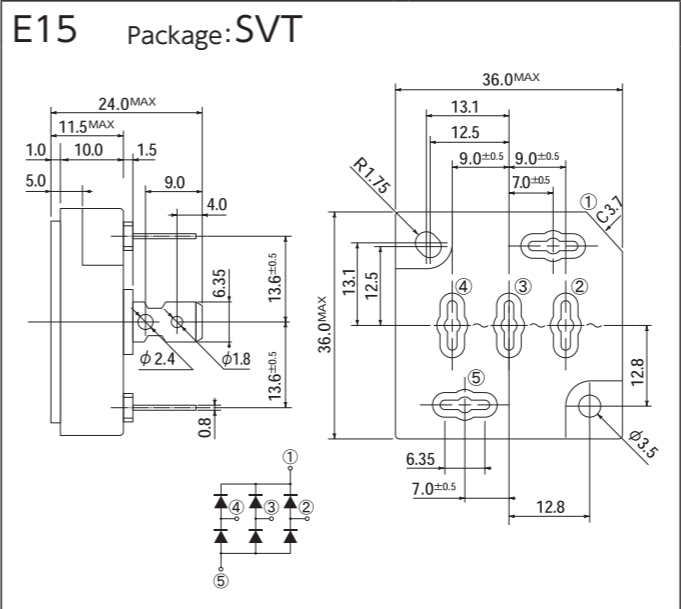
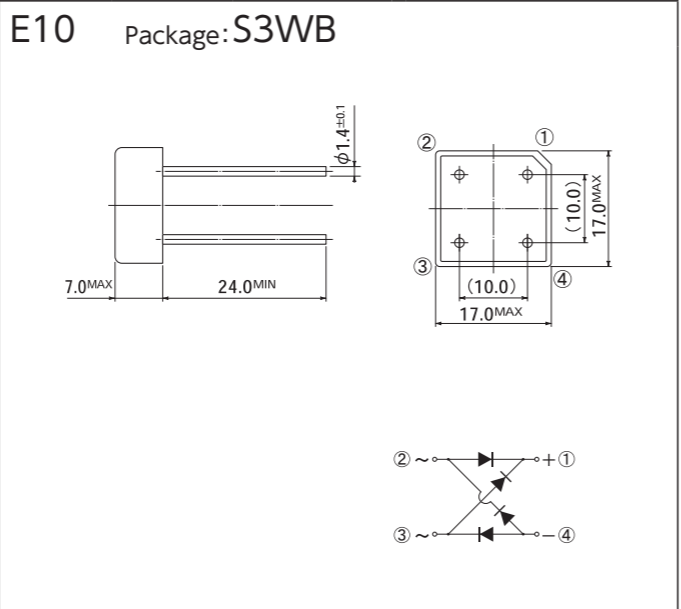
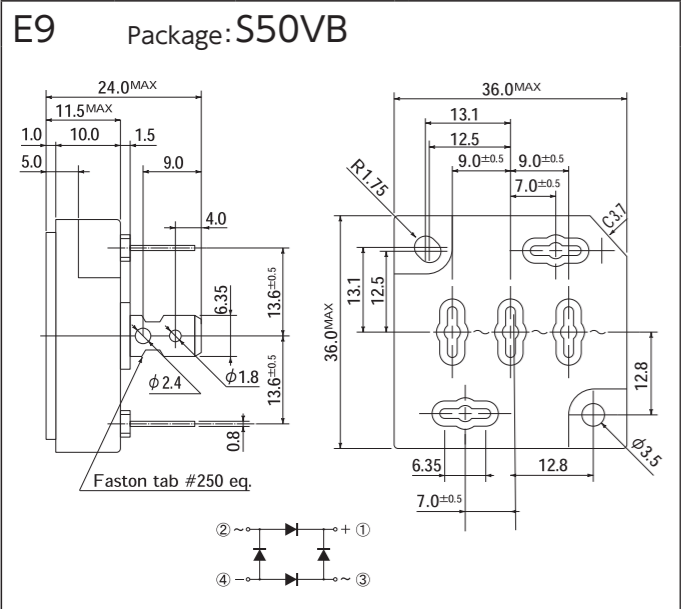
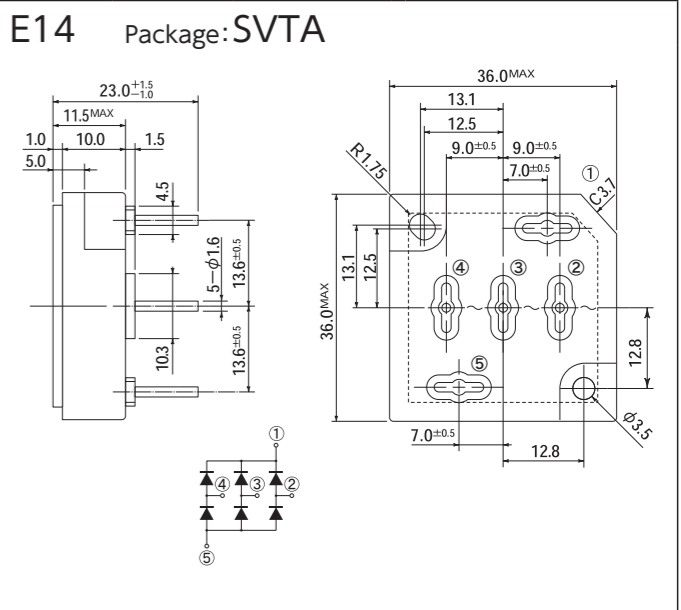

OUTLINE DIMENSIONS

[Unit:mm]

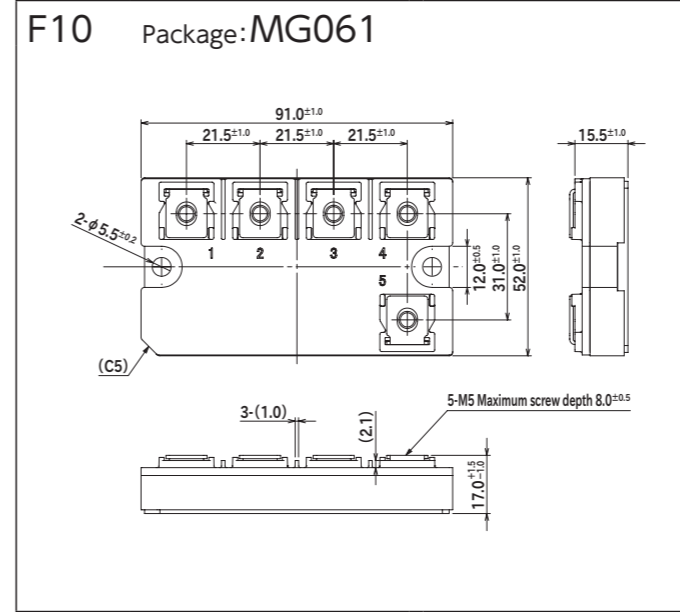
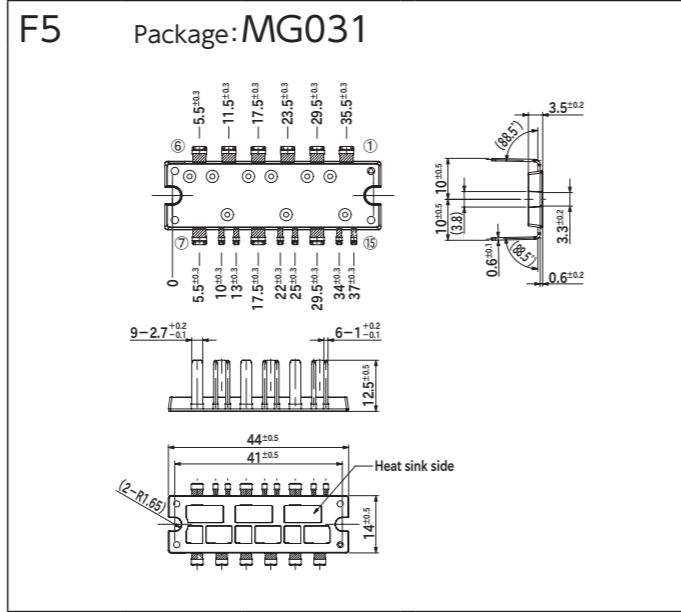
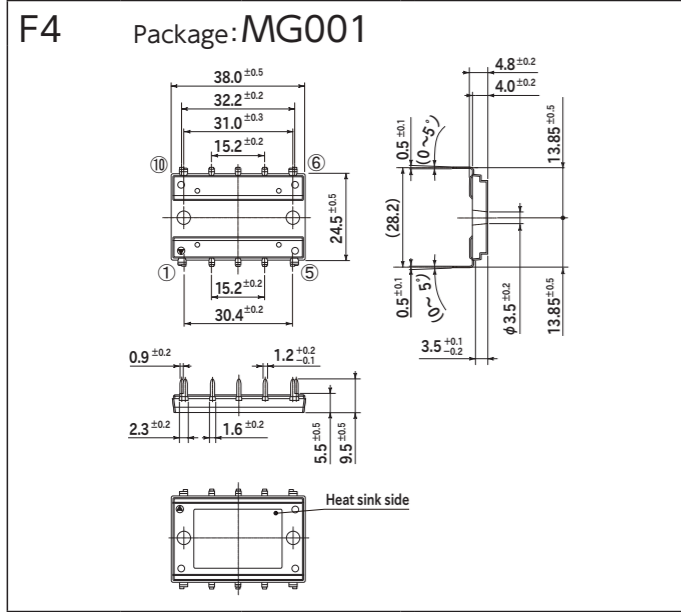

[Unit:mm]

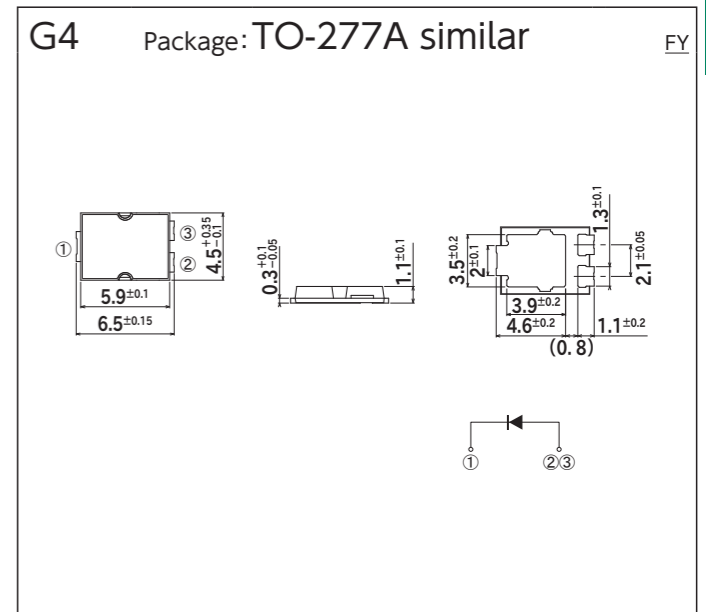
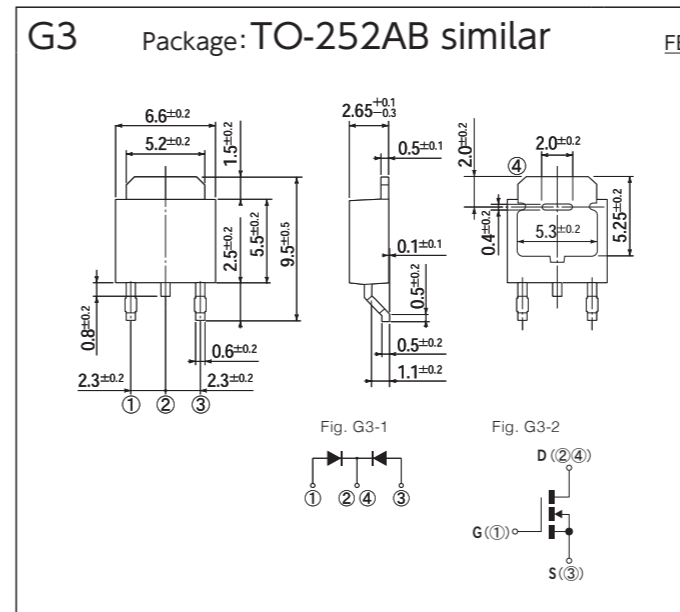
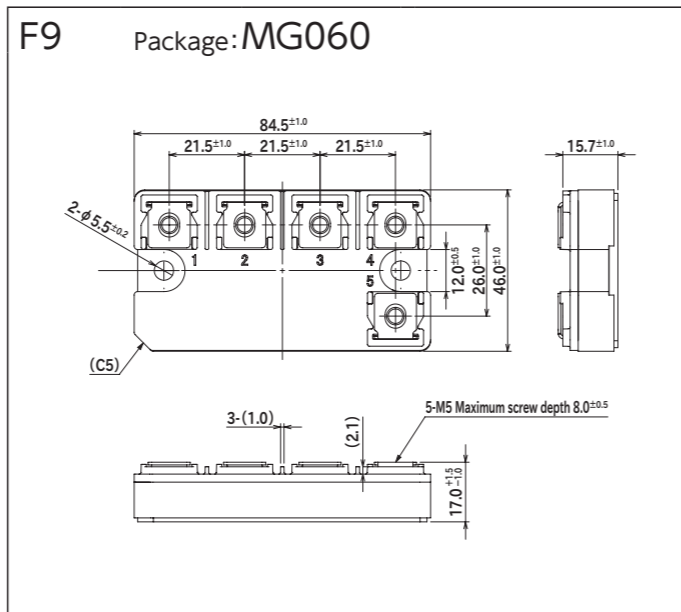
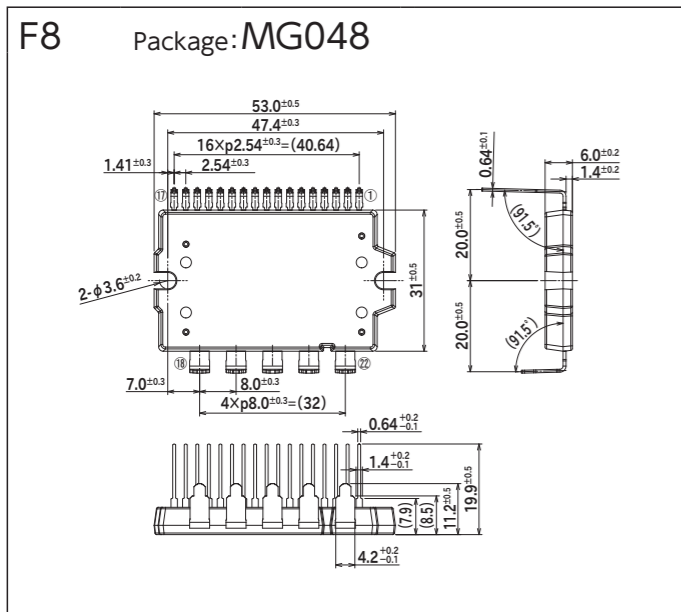
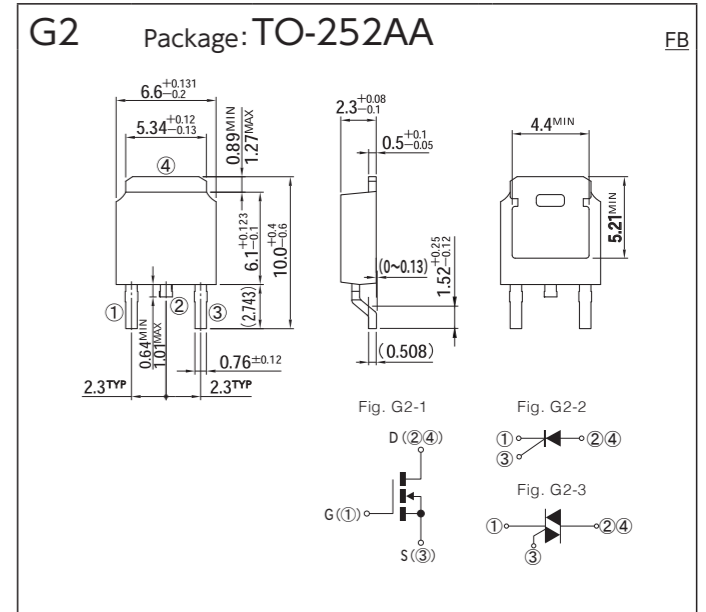
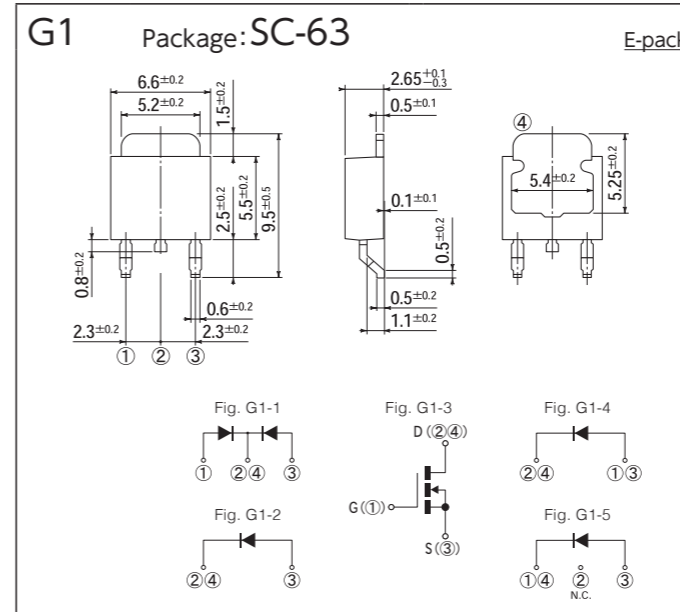
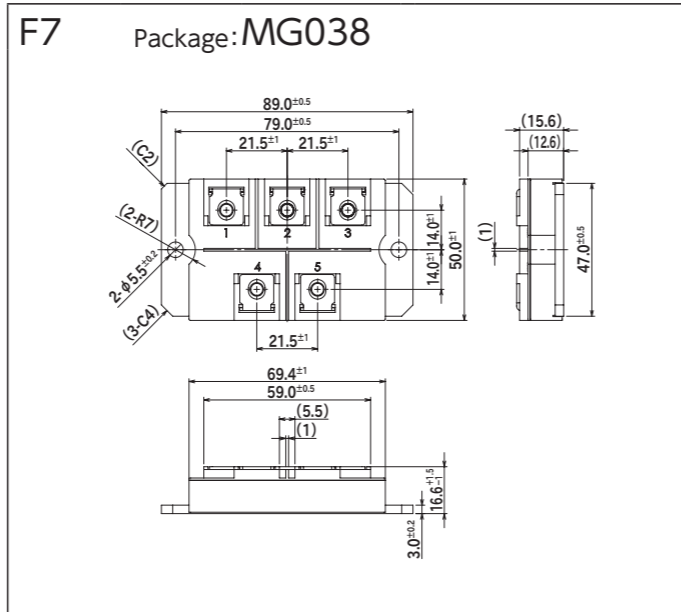
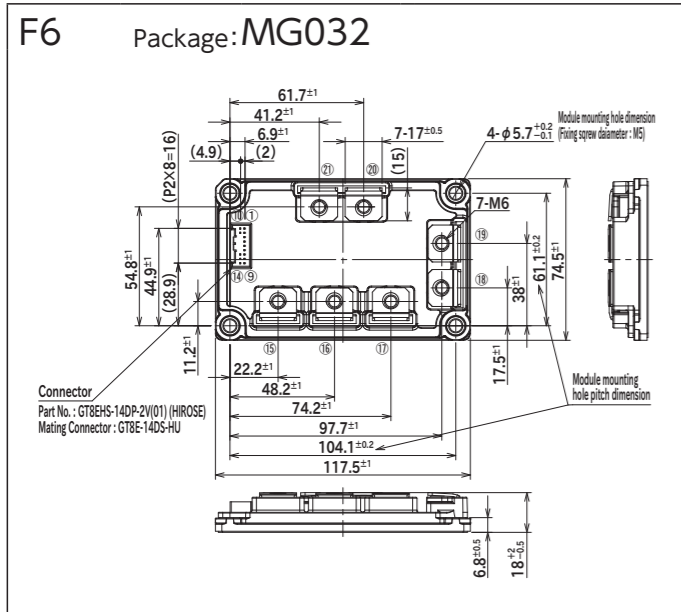
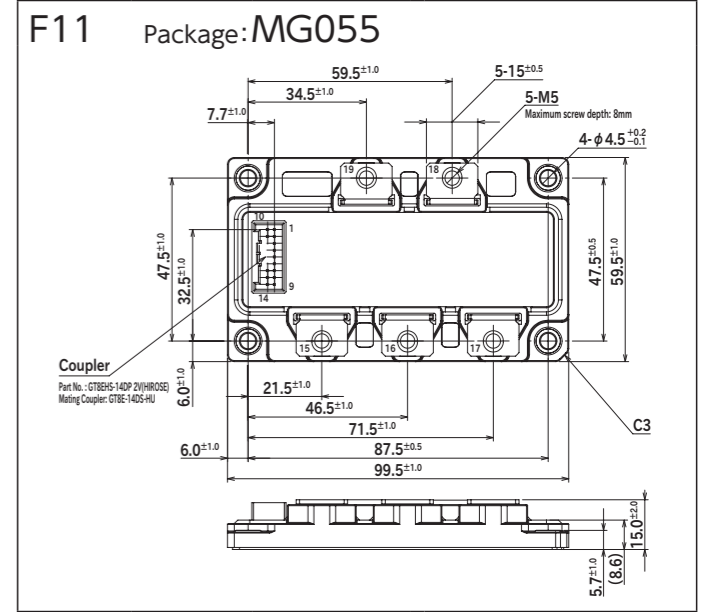

OUTLINE DIMENSIONS

[Unit:mm]

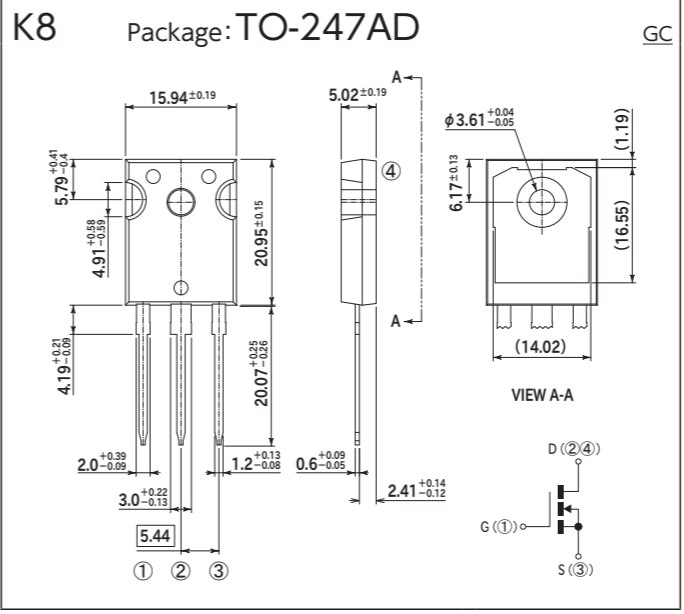
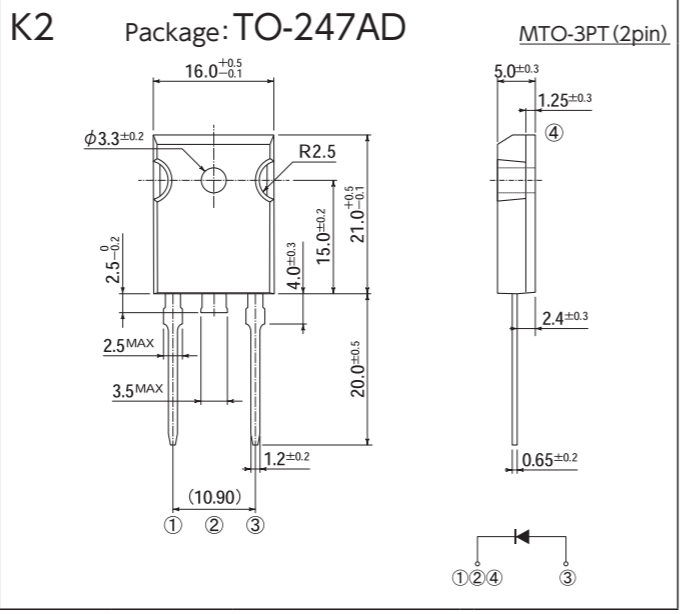
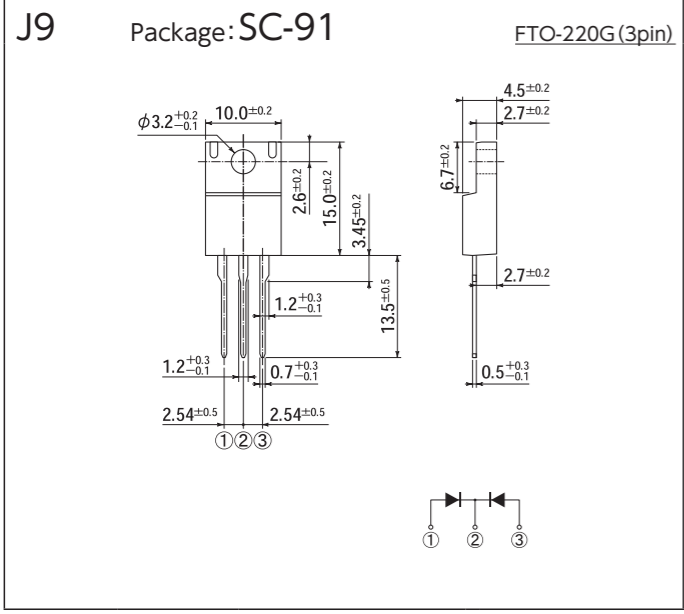
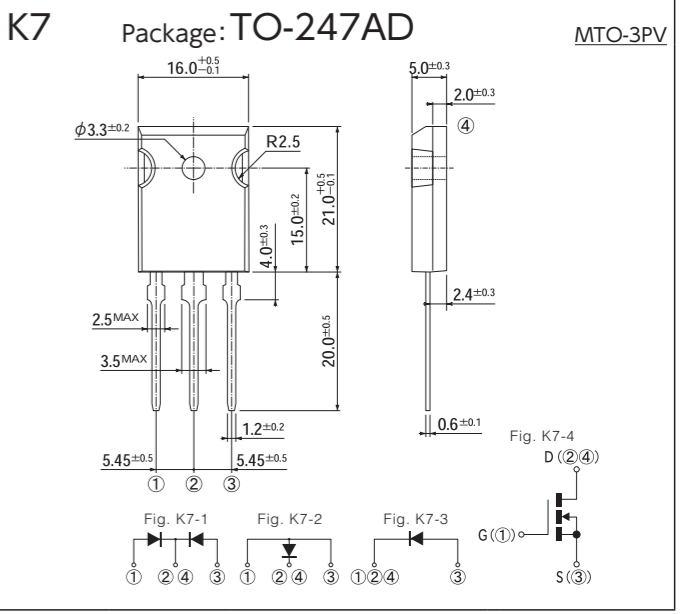
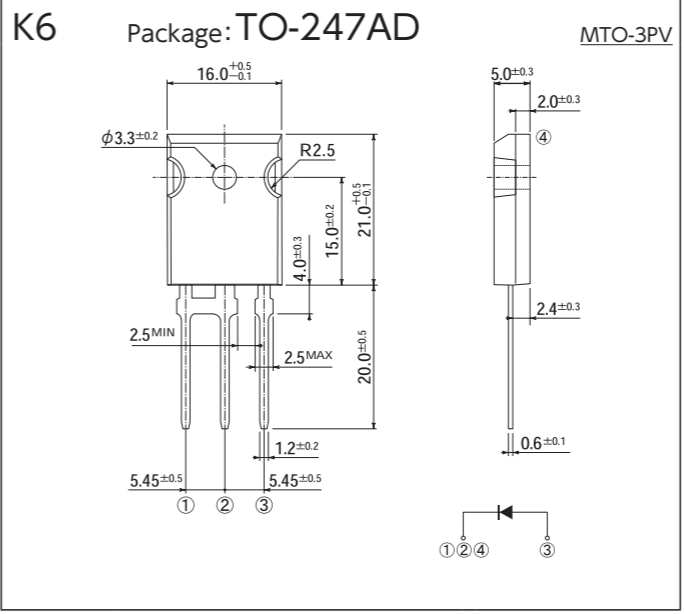
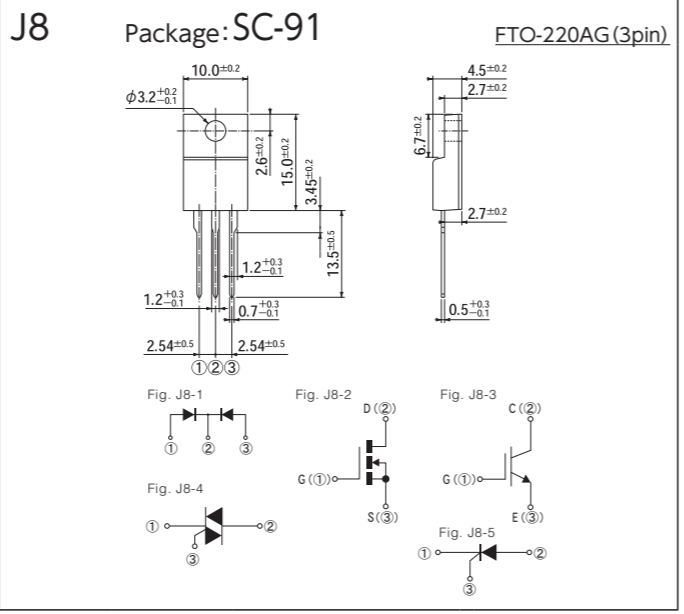
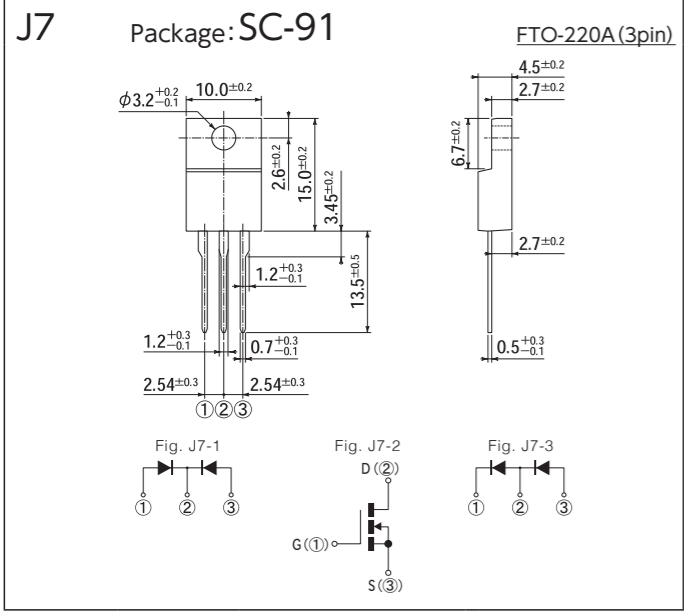
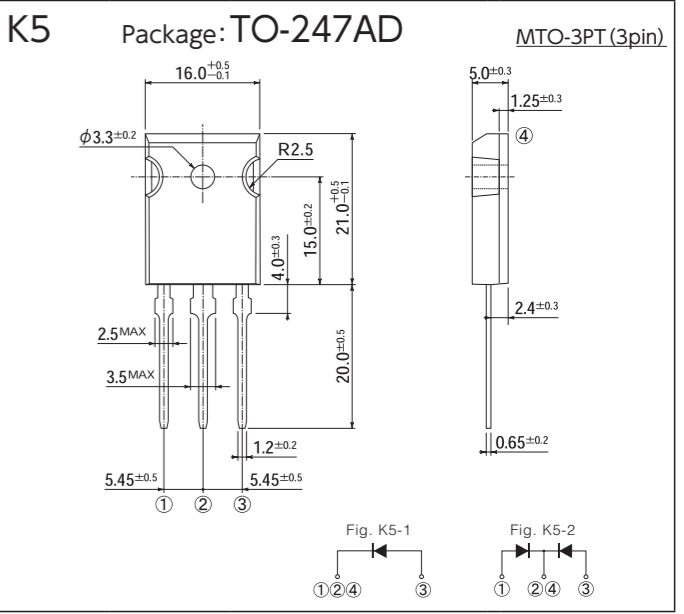
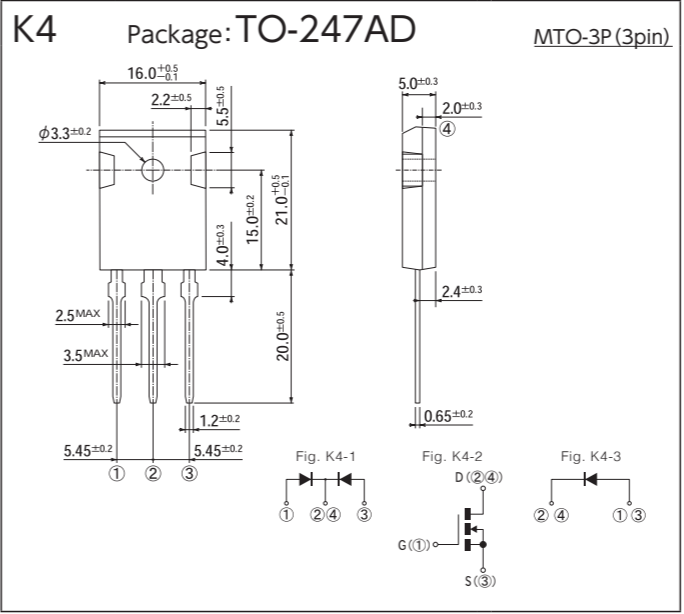
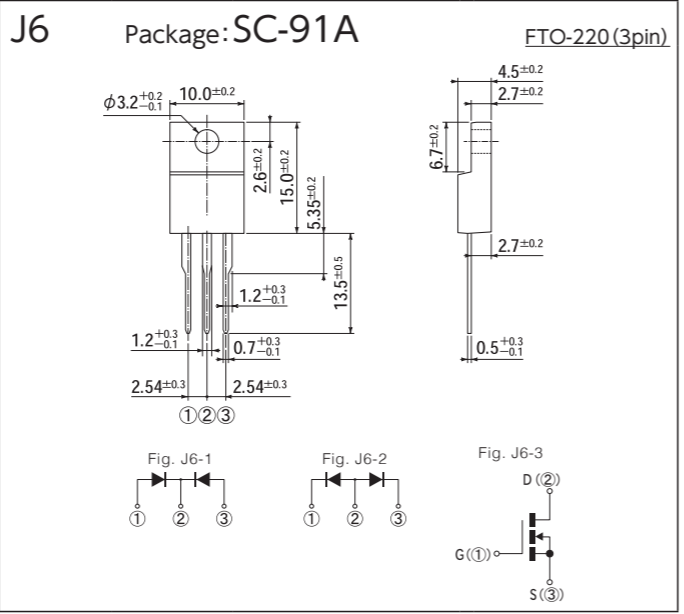
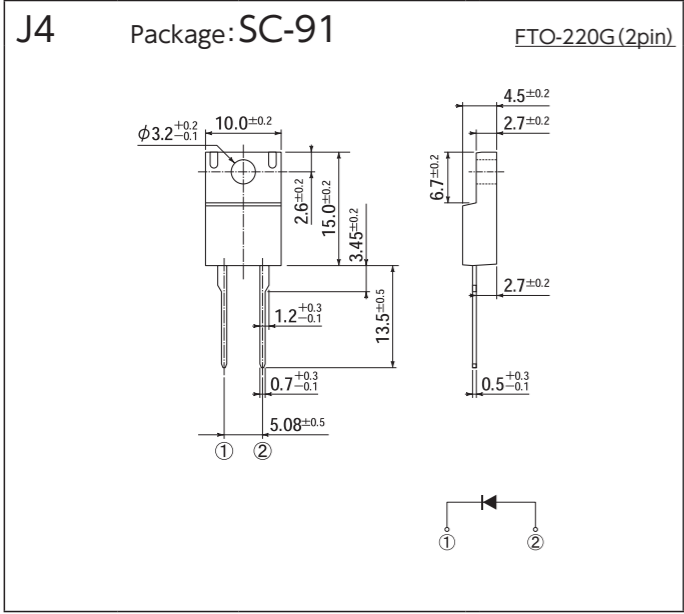

OUTLINE DIMENSIONS

OUTLINE DIMENSIONS

[Unit:mm]

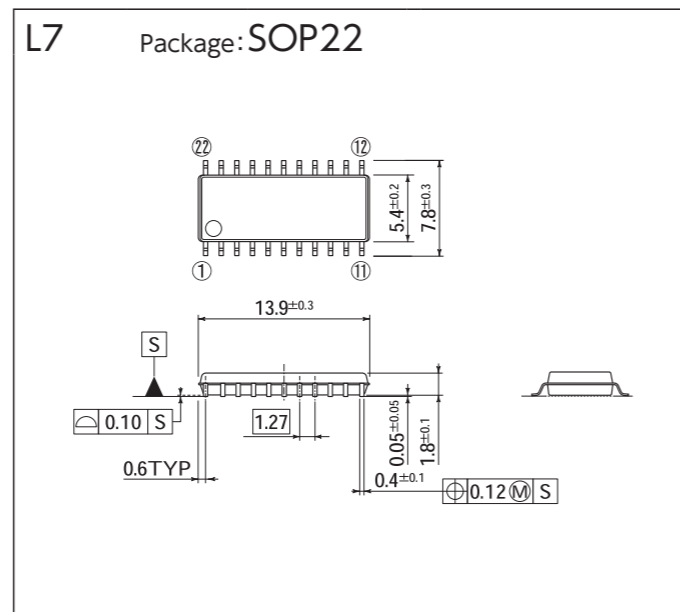
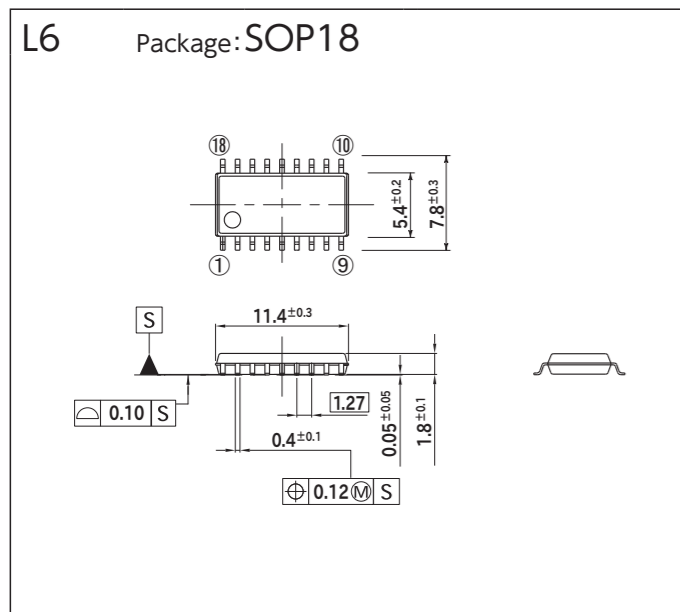
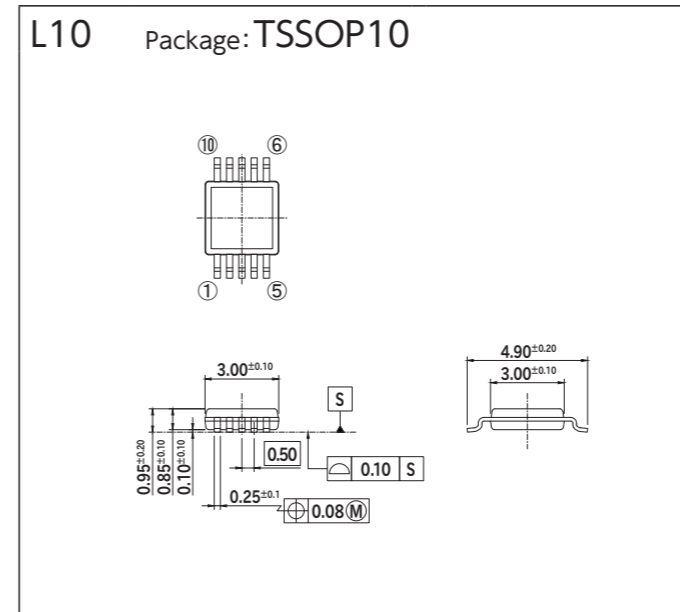
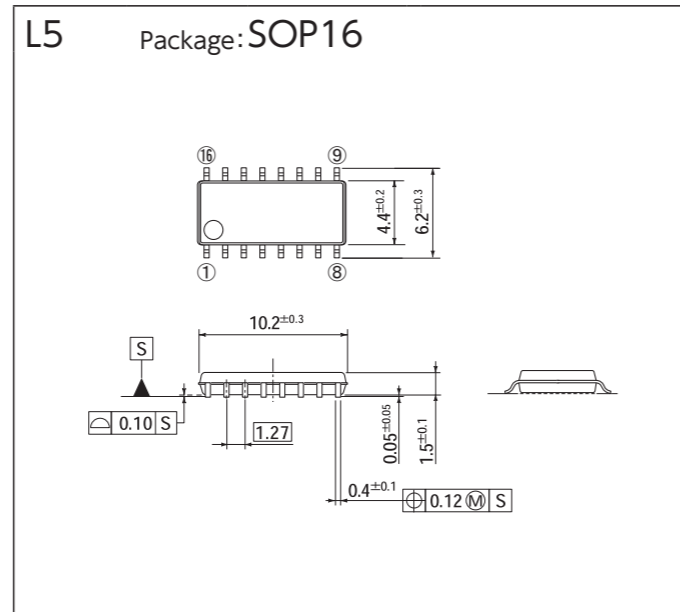
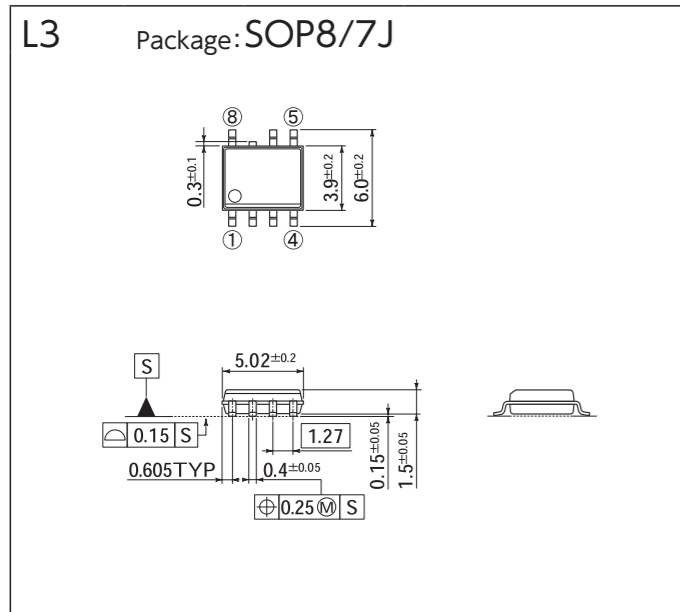
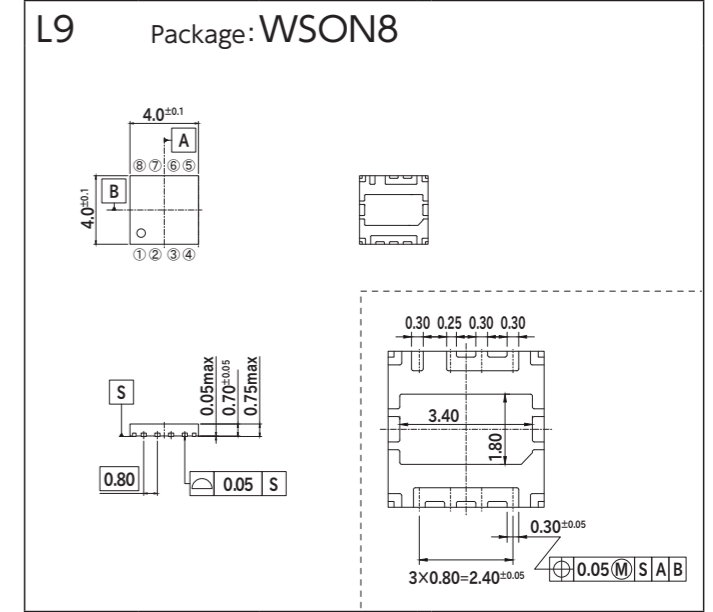
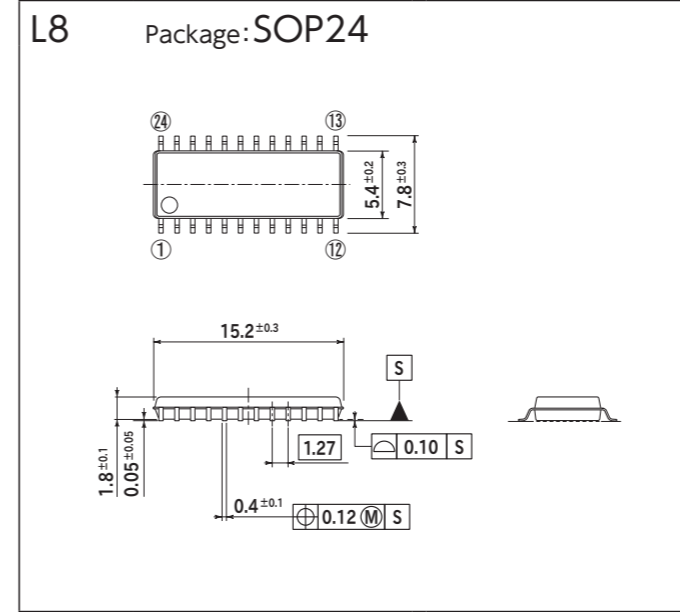
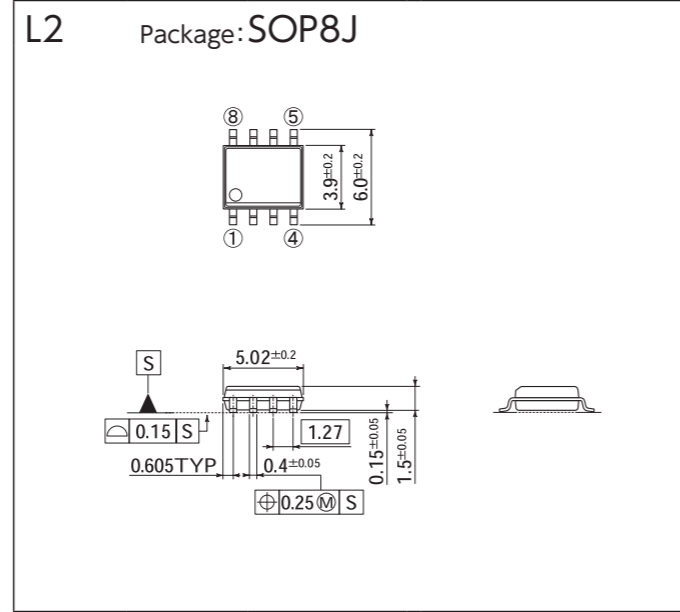
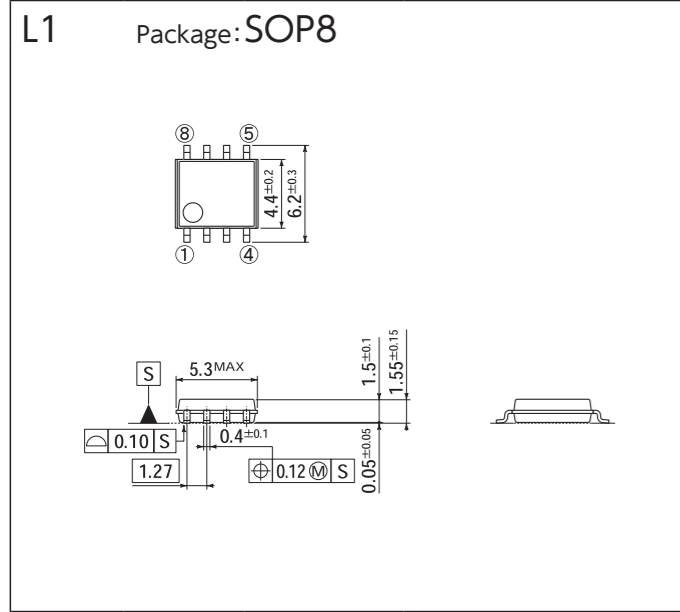

PACKING SPECIFICATION

Please make your order: 'more than Inner Box Quantities' and 'a multiple of each Packing Unit'

Order Quantity & Packing Dimensions List

Please make your order: 'more than Inner Box Quantities' and 'a multiple of each Packing Unit'

Package			Fig.	Spec Code	Terminal Plating	Weight (aprx.)	MSL	Remarks	Quantity	Inner Box			Standard Packing			Packing Box (mm)		
JEDEC Package Code	JEITA Code	House Name								Method	Quantity (Pcs./Box)	Pcs./Box	Weight (kg)	L	W	H		
-	-	AX057	A1	-5060	Sn	190mg	-		4,000	Tape,Ammo-Pack	52mm	4,000	32,000	7.5	330	280	270	
				-5070			Standard		3,000	Tape,Ammo-Pack	26mm	3,000	36,000	6.2	340	275	230	
				-7000					200	Bulk		200	20,000	5.9	480	355	230	
				-7060			Standard		4,000	Tape,Ammo-Pack	52mm	4,000	64,000	14.0	325	325	420	
				-7061					4,000	Tape&Reel,Diameter 300 φ	52mm	4,000	20,000	6.3	325	325	420	
				-7070					3,000	Tape,Ammo-Pack	26mm	3,000	72,000	15.7	325	325	420	
				-7000					200	Bulk		200	16,000	7.9	480	355	230	
				-7060			Standard		2,000	Tape,Ammo-Pack	52mm	2,000	32,000	14.7	325	325	420	
				-7070					1,500	Tape,Ammo-Pack	26mm	1,500	18,000	7.2	325	325	260	
				-5000					200	Bulk		200	16,000	7.9	480	355	230	
				-5060			Standard		2,000	Tape,Ammo-Pack	52mm	2,000	16,000	7.5	325	325	260	
				-5070					1,500	Tape,Ammo-Pack	26mm	1,500	18,000	7.2	325	325	260	
				-7000					200	Bulk		200	16,000	11.1	480	355	230	
				-7060			Standard		1,200	Tape,Ammo-Pack	52mm	1,200	18,000	14.4	325	325	420	
				-7061					2,500	Tape&Reel,Diameter 300 φ	52mm	2,500	12,500	10.8	325	325	420	
				-5000					200	Bulk		200	16,000	11.1	480	355	230	
				-5060			Standard		1,200	Tape,Ammo-Pack	52mm	1,200	9,600	7.3	325	325	260	
				-5061					2,500	Tape&Reel,Diameter 300 φ	52mm	2,500	12,500	10.8	325	325	420	
				-5000					200	Bulk		200	16,000	17.5	480	355	230	
				-5060			Standard		1,200	Tape,Ammo-Pack	52mm	1,200	9,600	11.2	325	325	260	
				-5061					2,500	Tape&Reel,Diameter 300 φ	52mm	2,500	10,000	13.0	350	355	350	
DO-219AB similar	SC-109	G1F	SMD	B1	-5063R	Sn	12mg	1	4,000	Tape&Reel,Diameter 180 φ		24,000	48,000	1.6	180	205	210	
DO-219AA similar	-	M1F	SMD	B2	-6063	Sn	25mg	1	2,500	Tape&Reel,Diameter 180 φ		15,000	75,000	4.5	405	210	220	
					-5103				100	Magazine		100	15,000	2.3	545	145	110	
					-5053			Standard	2,000	Tape&Reel,Diameter 180 φ		8,000	40,000	4.1	340	195	205	
					-5073				7,500	Tape&Reel,Diameter 330 φ		45,000	90,000	10.8	395	245	395	
					-5063R				3,000	Tape&Reel,Diameter 180 φ		12,000	24,000	1.6	180	205	210	
					-5063			Standard	1,000	Tape&Reel,Diameter 180 φ		4,000	20,000	3.4	340	195	205	
					-5073				4,000	Tape&Reel,Diameter 330 φ		4,000	48,000	8.6	395	245	395	
					-5103				60	Magazine		60	18,000	5.2	545	145	110	
					-5063			Standard	750	Tape&Reel,Diameter 180 φ		3,000	15,000	4.2	340	195	205	
					-5073				3,000	Tape&Reel,Diameter 330 φ		3,000	36,000	9.2	395	245	395	
					-7062				1,000	Tape&Reel,Diameter 180 φ		1,000	20,000	3.6	340	195	205	
					-7102				100	Magazine		100	15,000	3.2	545	145	110	
					-7062			S1ZA	750	Tape&Reel,Diameter 180 φ		3,000	15,000	4.0	340	195	205	
					-7062			S1ZB	750	Tape&Reel,Diameter 180 φ		3,000	15,000	4.0	405	210	220	
					-7072			Standard	3,000	Tape&Reel,Diameter 330 φ		3,000	15,000	4.6	340	340	120	
					-7102				100	Magazine		100	10,000	2.1	545	145	110	
					-7102				70	Magazine		70	5,600	4.1	545	145	100	
					-7062				1,000	Tape&Reel,Diameter 250 φ		1,000	10,000	5.5	275	285	295	
					-7101				70	Magazine		70	5,600	4.1	545	145	100	
					-7102			Standard	1,000	Tape&Reel,Diameter 250 φ		1,000	10,000	5.5	275	285	295	
					-7101				70	Magazine		70	5,600	4.1	545	145	100	
					-7102				50	Magazine		50	4,000	4.4	545	145	110	
					-7062				1,000	Tape&Reel,Diameter 330 φ		3,000	6,000	5.5	395	245	395	
					-7072				2,000	Tape&Reel,Diameter 380 φ		2,000	10,000	7.8	395	245	395	
					-7101				50	Magazine		50	4,000	4.4	545	145	110	
					-7000				500	Bulk		500	2,500	4.0	210	188	200	
					-7000				100	Bulk		500	6,000	14.4	410	380	170	
					-7000				250	Bulk		250	2,000	9.5	310	285	196	
					-7000				50	Bulk		250	2,000	14.5	330	330	215	
					-7000				250	Bulk		250	2,000	7.4	287	301	169	
					-7000				250	Bulk		250	2,000	9.0	327	329	185	
					-7000				100	Bulk		100	400	9.8	351	269	164	
					-7500				40	Tray		40	200	5.6	503	356	135	
					-7500				40	Tray		40	200	5.6	503	356	135	
					-7501				40	Tray		40	200	5.6	503	356	135	
					-7000				500	Bulk		500	2,000	8.0	260	220	222	
					-4062			Standard	300	Tape&Reel,Diameter 255 φ		300	1,500	5.0	280	275	190	
					-4072				600	Tape&Reel,Diameter 330 φ		600	1,800	5.5	335	345	110	

Package			Fig.	Spec Code	Terminal Plating	Weight (aprx.)	MSL	Remarks	Quantity	Inner Box			Standard Packing			Packing Box (mm)		
JEDEC Package Code	JEITA Code	House Name								Method	Quantity (Pcs./Box)	Pcs./Box	Weight (kg)	L	W	H		
-	-	D30VC	THD	E2	-4000	Ag	12g	-	100	Tray		100	500	7.0	375	285	160	
-	-	S2VB	THD	E3	-5000	Sn-Ag-Cu	3.0g	-	100	Tray		100	1,000	3.6	265	255	170	
-	-	S4VB	THD	E4	-5000	Sn-Ag-Cu	5.2g	-	100	Tray		100	1,000	5.9	315	285	220	
-	-	S5VB	THD	E5	-5000	Sn-Ag-Cu	9.1g	-	100	Tray		100	1,000	10.4	415	285	300	
-	-	S10VB	THD	E6	-5000	Sn-Ag-Cu	8.0g	-	100	Tray		100	1,000	9.3	375	285	270	
-	-	S15VB	THD	E7	-4000	Ag	16g	-	100	Tray		100	500	9.0	415	285	180	
-	-	S25VB	THD	E8	-4000	Ag	21g	-	60	Bulk		60	300	7.0	335	205	165	
-	-	S50VB	THD	E9	-4000	Ag	28g	-	50	Tray		50	200	6.2	335	205	165	
-	-	S3WB	THD	E10	-5000	Sn-Ag-Cu	5.1g	-	100	Tray		100	1,000	6.1	315	285	220	
-	-	S10WB	THD	E11	-5000	Sn-Ag-Cu	9.0g	-	100	Tray		100	1,000	9.3	375	285	270	
-	-	S15WB	THD	E12	-5000	Sn-Ag-Cu	16g	-	100	Tray		100	1,000	15.1	415	285	300	
-	-	S20WB	THD	E13	-5000	Sn-Ag-Cu	20g	-	100	Tray		100	700	15.0	415	285	300	
-	-	SVTA	THD	E14	-5000	Sn-Ag-Cu	30g	-	50	Tray		50	250	8.7	460	295	240	
-	-	SVT	THD	E15	-4000	Ag	31g	-	45	Bulk		200	200	13.6	335	205	165	
-	-	MODULE	-	F1 F2 F3	-4000	Ni	42-66g	-	25	Tray		100	200	13.4	480	330	210	
-	-	MG001	THD	F4	-7101	Sn-Bi	10g	-	15	Magazine		15	450	7.1	623	232	144	
-	-	MG031	THD	F5	-7101	Sn-Bi	7.7g	-	12	Magazine		12	600	8.5	573	281	127	
-	-	MG032	-	F6	-4500	Ni	340g	-	24	Tray		24	24	8.0	610	315	140	
-	-	MG038	-	F7	-4500	Ni	180g	-	40	Tray		40	40	9.0	425	360	155	
-	-	MG048	THD	F8	-7101	Sn-Bi	7.											

NOTES

How to Order

1. Indication of Spec. Code when ordering

Please specify the Spec. Code when ordering semiconductors.
For the Spec. Code, Please refer to as follows and "PACKING SPECIFICATION".

Example Ordering THD type of S1ZB60
S1ZB60-7101

2. Spec Code

The code specifies each packing form, lead forming and terminal plate material.
Please refer to "PACKING SPECIFICATION".

Example 5 0 0 0

- Terminal forming
 - 0 : Straight terminal
 - 1 to 9 : Each number shows type of form
- Packing form
 - 0 : Standard
 - In case of surface mounting devices
 - 5, 6 : Small reel
 - 7 : Large reel
 - In case of axial device
 - 6 : Lead length 52mm (T52)
 - 7 : Lead length 26mm (T26)
- Minimum packing unit
 - 0 : Bulk, tray or taping
 - 1 : Magazine
 - 5 : Tray
 - 6 : Packed (FTO-220 Package)
- Terminal plate material
 - 3 : Ni/Pd/Au, Sn-Ag
 - 4 : Ni, Ag
 - 5 : Sn-Ag-Cu, Sn, Ag, Sn-Cu
 - 6 : Sn
 - 7 : Sn-Bi

Outline of Packing Form

1. Minimum packing unit

- Bulk : The form in which parts are inserted into plastic bags or cardboard boxes.
- Tray : The form in which parts are inserted in to containers made of resin.



- Magazine : The form in which parts are inserted into resin cartridges designated for automatic inserters.



- Taping
 - Reel (Surface mounting devices)



- Box (Axial devices)



2. Packing Box Dimensions

See the following pages for the dimensions of each cardboard box.

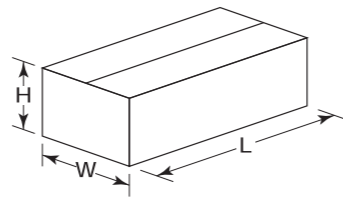

About AEC-Q101 & Automotive Grade

1. AEC-Q101

These products are based on AEC-Q101.

2. Automotive Grade

These products are produced on a designated production line qualified for internal automotive standards.

Sales Offices

U.S.A.

Shindengen America, Inc.

1540E, Dundee Road Suite 350 Palatine IL.60074. U.S.A.
Phone:+1-847-444-1363 FAX:+1-847-444-0654

Europe

Shindengen UK Ltd.

Head Office

6th Floor, 2 Kingdom Street. London, W2 6BD, U.K.
Phone:+44-20-8187-4997 FAX:+44-20-3725-6855

German Branch

Prinzenallee 1, 40549 Düsseldorf, Germany
Phone:+49-211-5206590 FAX:+49-211-4986499

Asia

Shindengen Singapore Pte Ltd.

750D, Chai Chee Road, #05-01, ESR BizPark
@ Chai Chee, Singapore 469004.
Phone:+65-6445-0082 FAX:+65-6445-6089

Shindengen (H.K.) Co., Ltd.

Head Office

Suite 2006B, 20/F., Exchange Tower, 33 Wang Chiu Road,
Kowloon Bay, HK
Phone:+852-2317-1884 FAX:+852-2314-8561

Taiwan Representative Office

3F-1., No.126, Songjiang Road, Zhongshan District,
Taipei City 10457, Taiwan, R.O.C.
Phone:+886-2-2100-1218 FAX:+886-2-2100-2018

Shindengen (SHANGHAI) Electric Co., Ltd.

Room1506, Sheng Gaolnt'l Building, 137 Xian Xia Road,
Chang Ning, Shanghai, China
Phone:+86-21-6270-8000 FAX:+86-21-6270-0419

Shindengen Electric Mfg. Co., Ltd.

Seoul Office

B701-4. 230, Simin-daero, Dongan-gu, Anyang-si,
Gyeonggi-do, 14067 Korea
Phone:+82-31-385-1431 FAX:+82-31-385-1430

Japan

Shindengen Electric MFG. Co., Ltd.

Head Office

New-Ohtemachi Bldg., 2-2-1, Ohtemachi, Chiyoda-ku,
Tokyo 100-0004, Japan
Phone:+81-3-3279-4431 FAX:+81-3-3279-6478

Asaka Office

3-14-1, Saiwai-cho, Asaka City,
Saitama 351-8503, Japan
Phone:+81-48-483-5311 FAX:+81-48-483-4117

Osaka Branch Office

Minami Senba Heart Bldg., 2-3-2, Minami-Senba,
Chuo-ku, Osaka City, Osaka 542-0081, Japan
Phone:+81-6-6264-7770 FAX:+81-6-6260-1222

Nagoya Branch Office

Nagoya Daiichi Bldg., 1-19-24, Nishiki, Naka-ku,
Nagoya City, Aichi 460-0003, Japan
Phone:+81-52-221-1361 FAX:+81-52-201-4780

Hamamatsu Sales Office

Hamamatsu Daiichi Seimei Nittsu Bldg., 110-5, Itaya-cho,
Naka-ku, Hamamatsu City, Shizuoka 430-0928, Japan
Phone:+81-53-450-3800 FAX:+81-53-450-3801

Utsunomiya Sales Office

Flora Bldg., 1-9-15 Higashi Syukugou Utsunomiya City,
Tochigi 321-0953, Japan
Phone:+81-28-637-3615 FAX:+81-28-637-3115

HP Address

Japanese : <https://www.shindengen.co.jp/>
English : <https://www.shindengen.com/>
Chinese : <https://cn.shindengen.co.jp/>
Korean : <https://kr.shindengen.co.jp/>

- All specifications are subject to change without notice.
- Please consult us for the latest specifications before you order.
- Please use this products after reading manual well.

• Printed January 2023

This catalog includes the products which might be subject to the foreign exchange and foreign trade laws.

Package Outline

* = Similar Package



DO-219AB*
G1F



DO-219AA*
M1F



DO-214AC
1F, CF



SC-110B
CE



DO-214AA*
M2F



2F



TO-277A*
FY

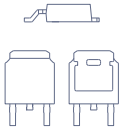

TO-252AA
FB

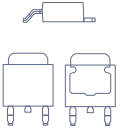

SC-63
E-pack

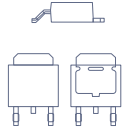

TO-252AB*
FE

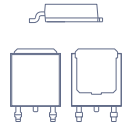

TO-252AA*
FR

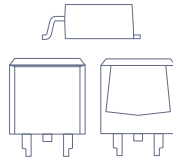

SC-83*
STO-220, FD

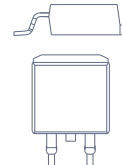

TO-263AB
FZ

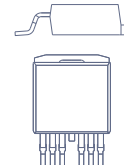

TO-263SC
FZ-7p



MCP



MO-235B*
LF

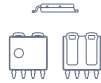

LF_Dual



SOP8
SOP8J



SOP16



SOP18



SOP22



SOP24

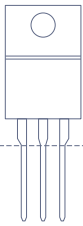

SC-91
FTO-220A, 220AG

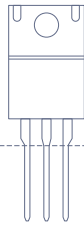

SC-91
FTO-220G

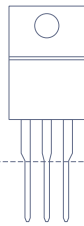

SC-91A
FTO-220

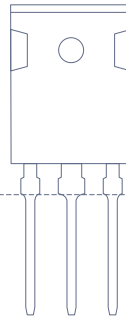

TO-247AD
MTO-3P, 3PT, 3PV

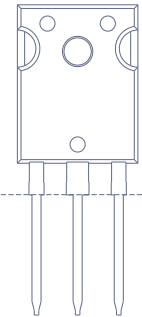
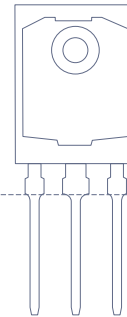

TO-247AD
GC



SOPA-4



TO-269AA
1Z



1N



1NA



1W

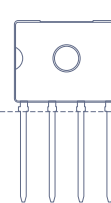

D3K

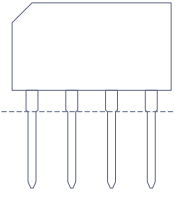

2S

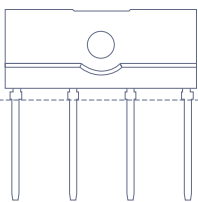

JB

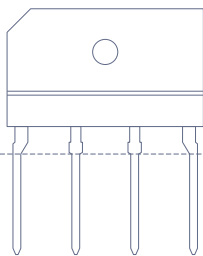

3S

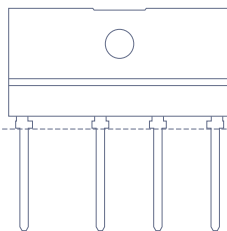

JA

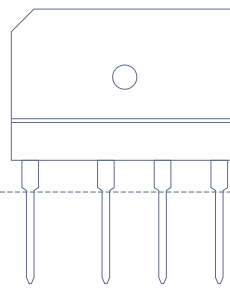

5S

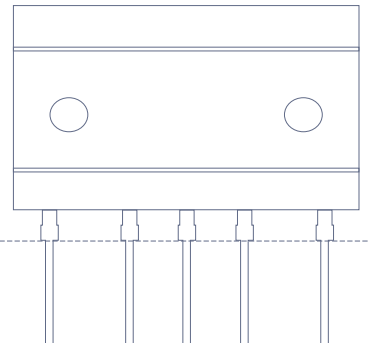

TSB, JC

Shindengen Electric Manufacturing Co., Ltd.

www.shindengen.com



CAT.NO.F072-16

2301-2000(1)